

LIQUEUR TABLE

LQ_TB.120x90

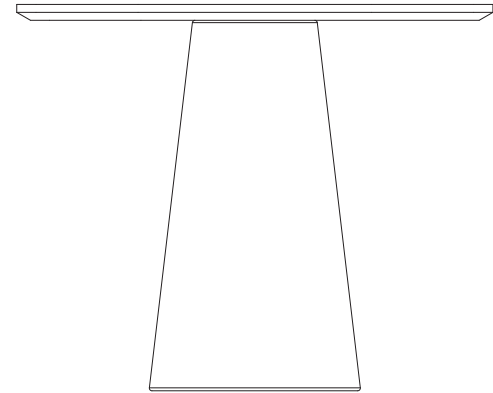
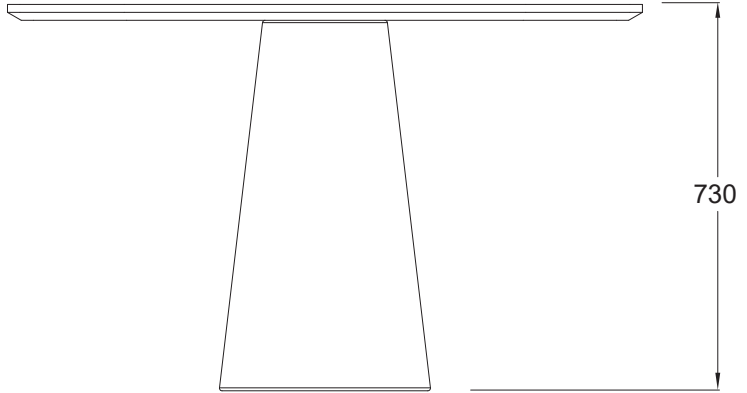
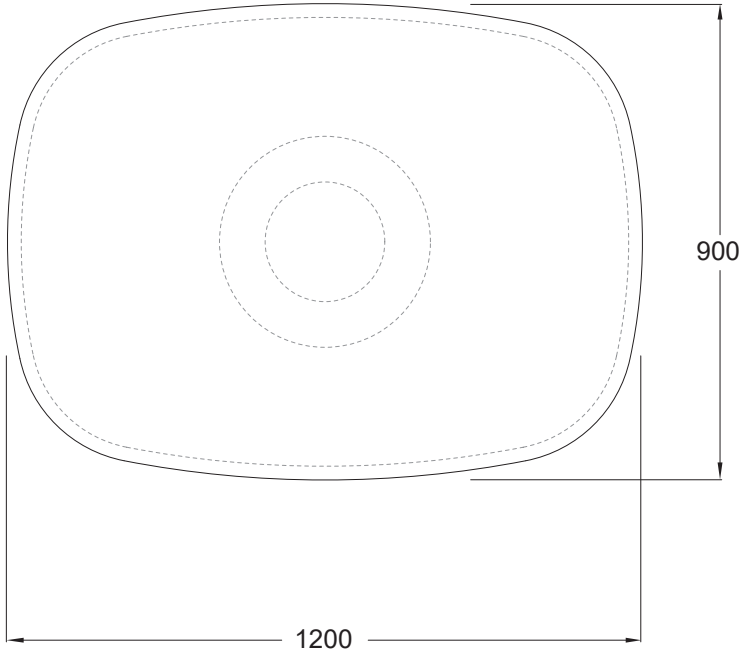

LIQUEUR TABLE

LQ_TB.180x90

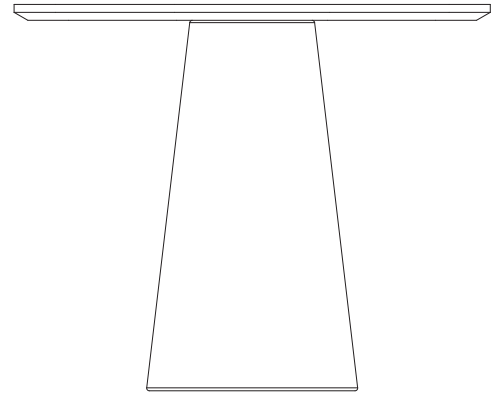
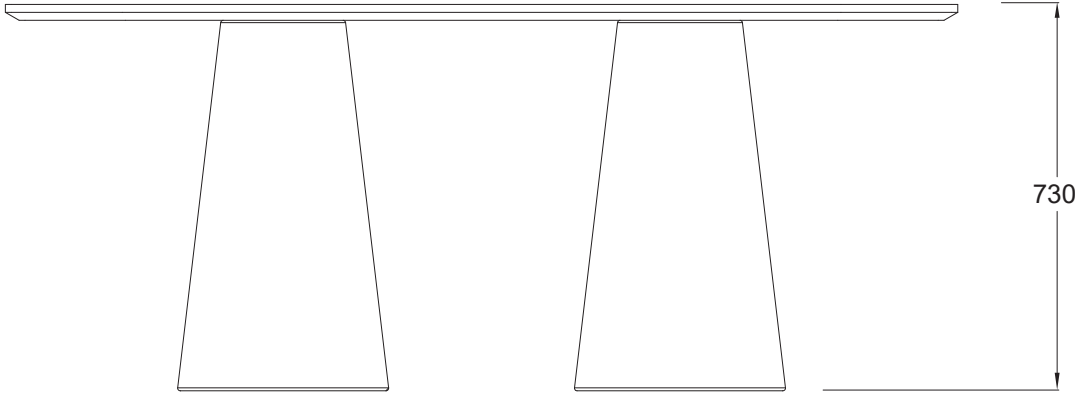
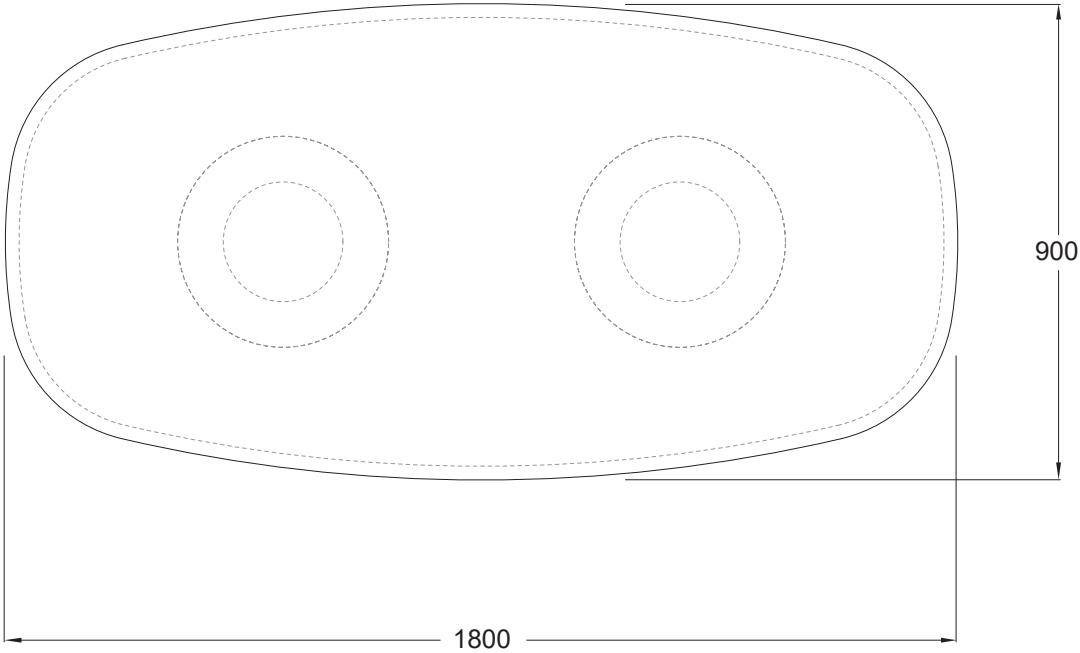

LIQUEUR TABLE

LQ_TB.210x90

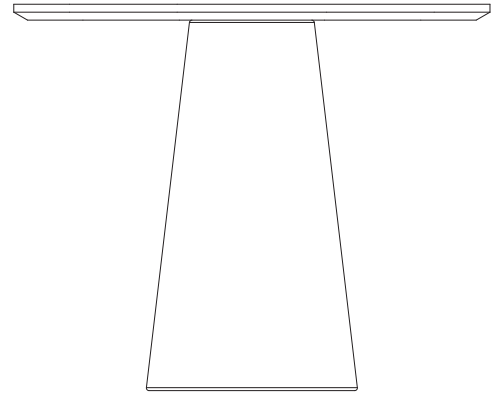
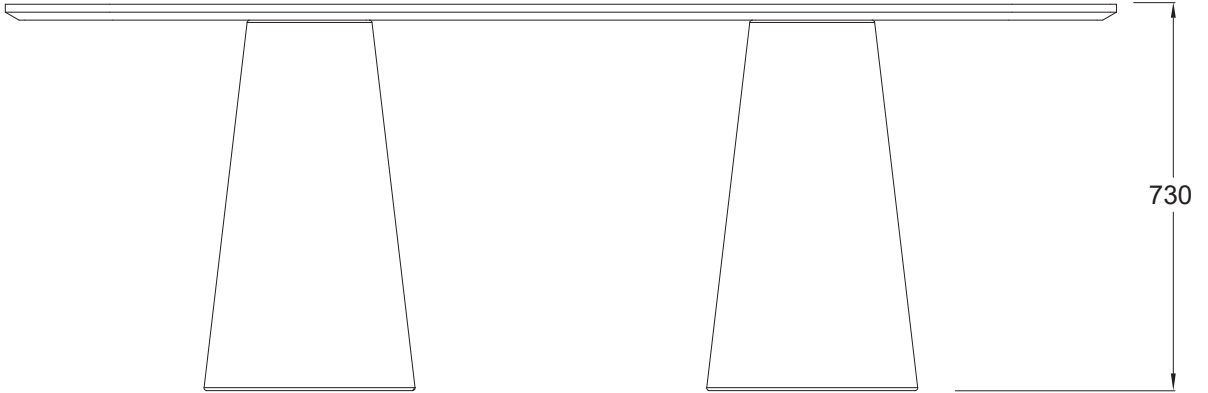
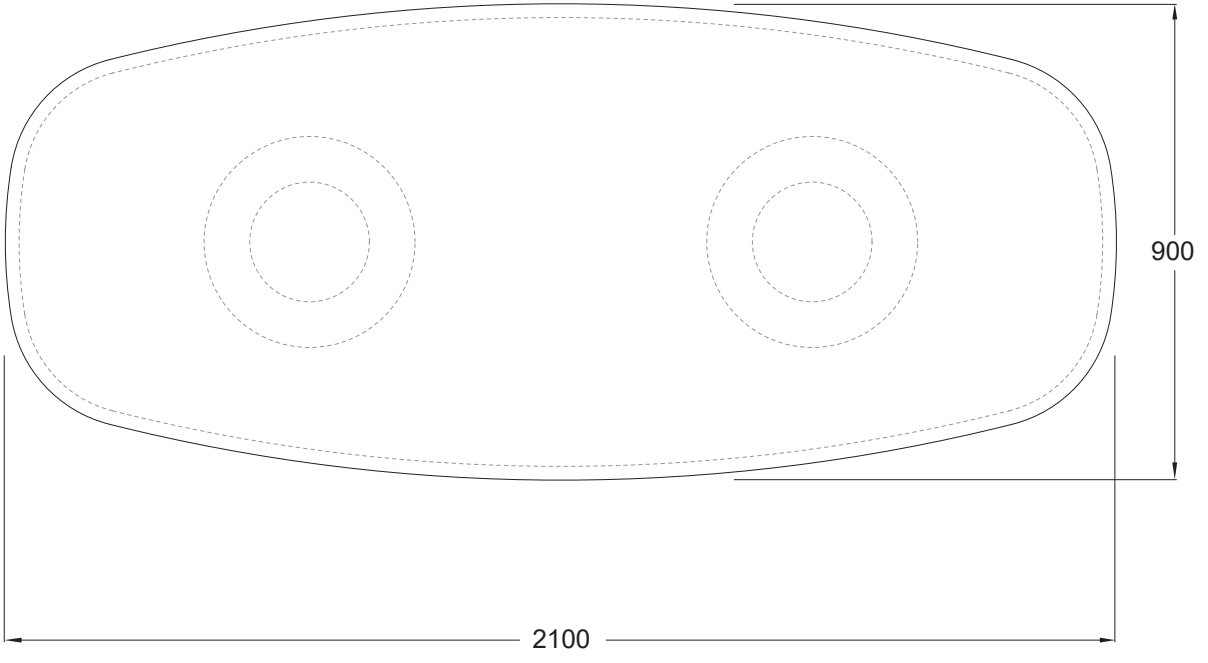

LIQUEUR TABLE

LQ_TB.240x90

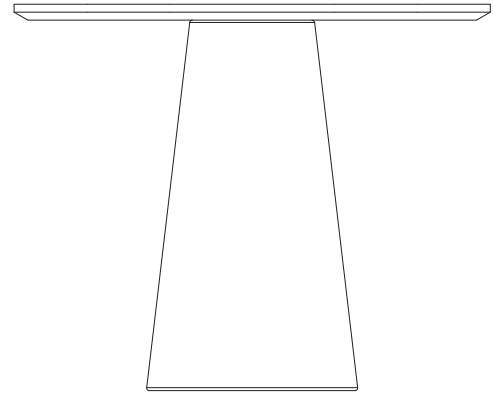
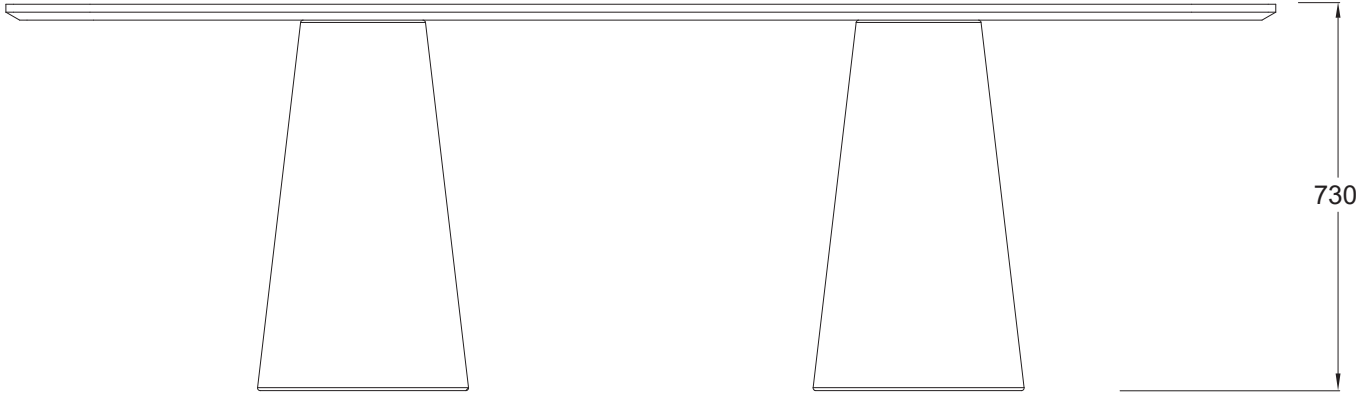
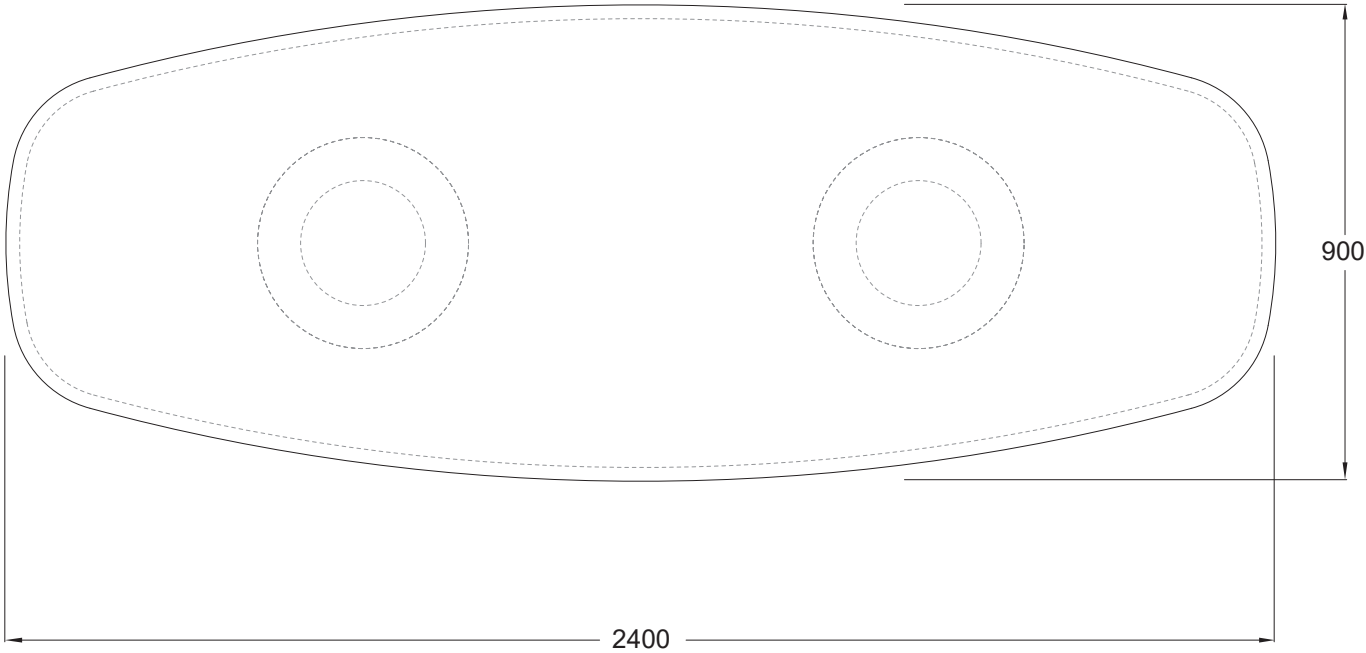

LIQUEUR TABLE

LQ_TB.270x90

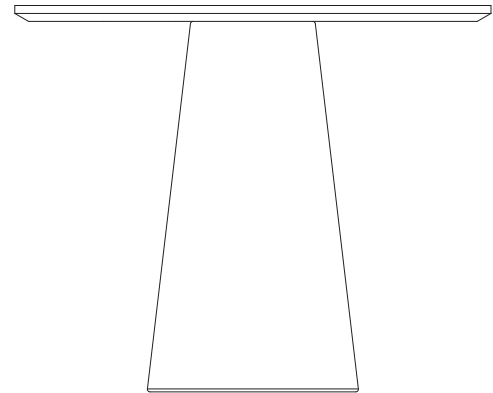
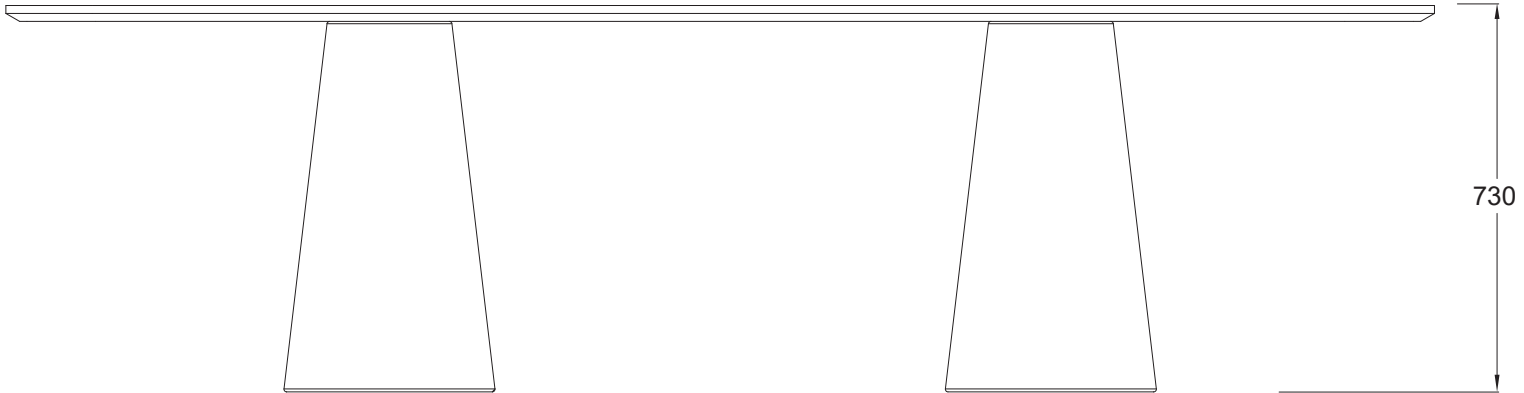
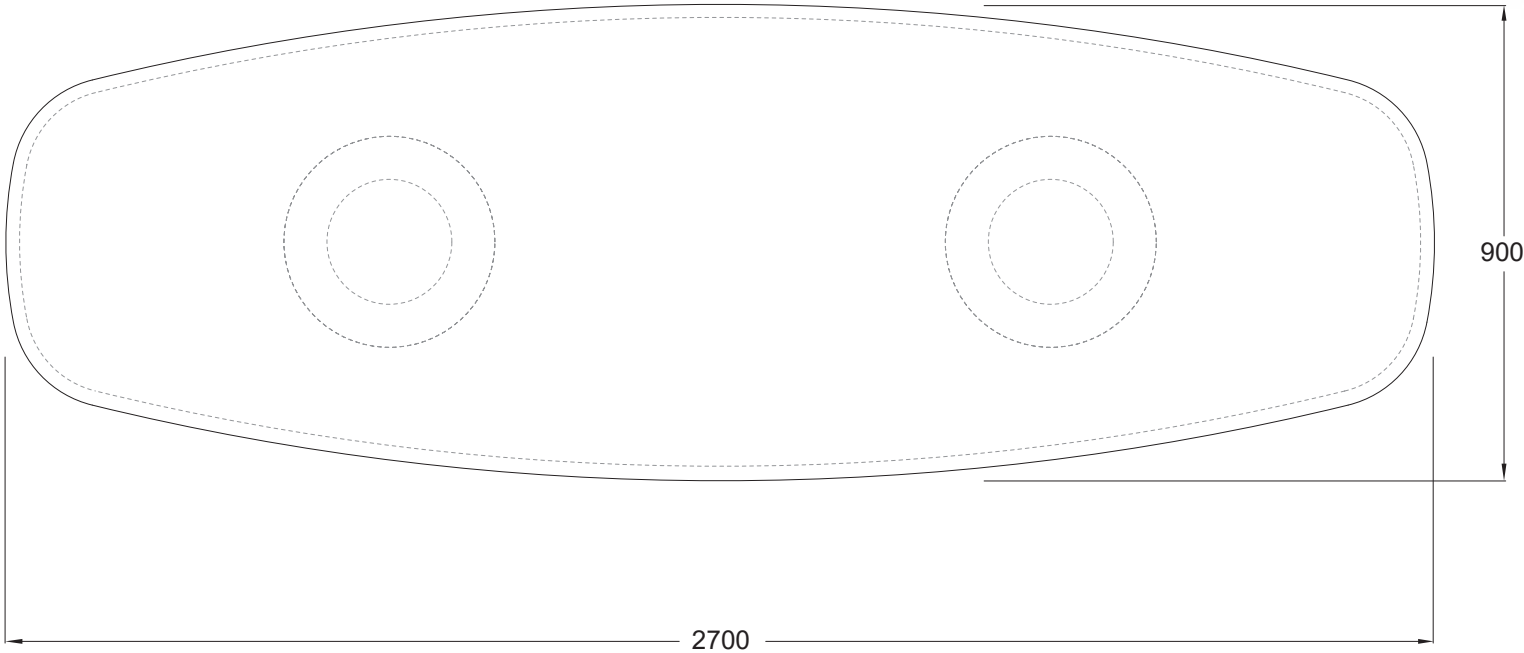

LIQUEUR TABLE

LQ_TB.150x120

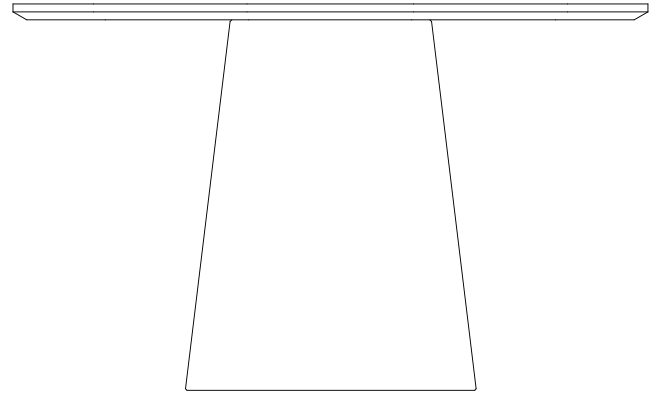
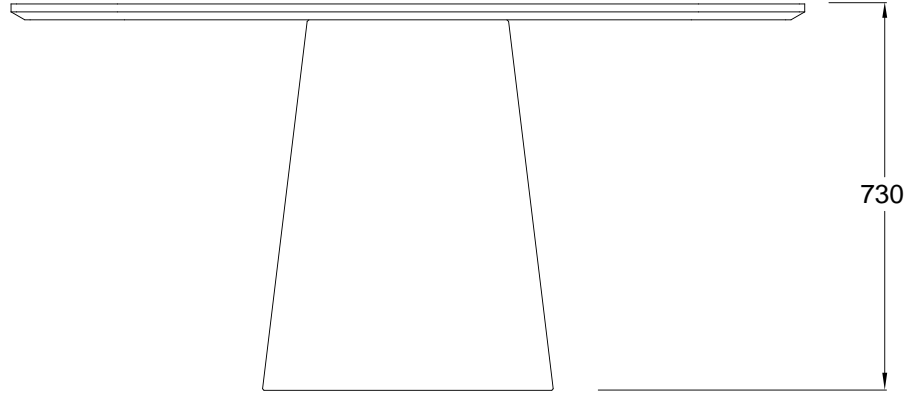
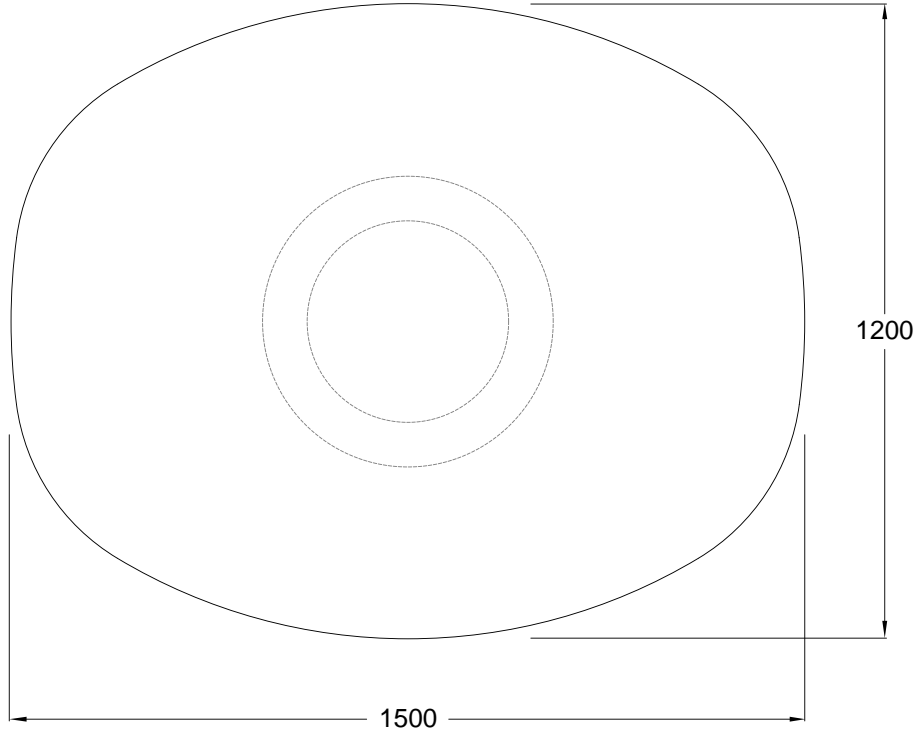

LIQUEUR TABLE

LQ_TB.180x120

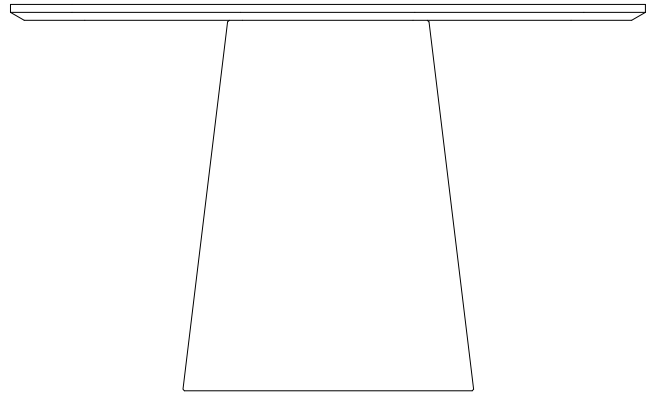
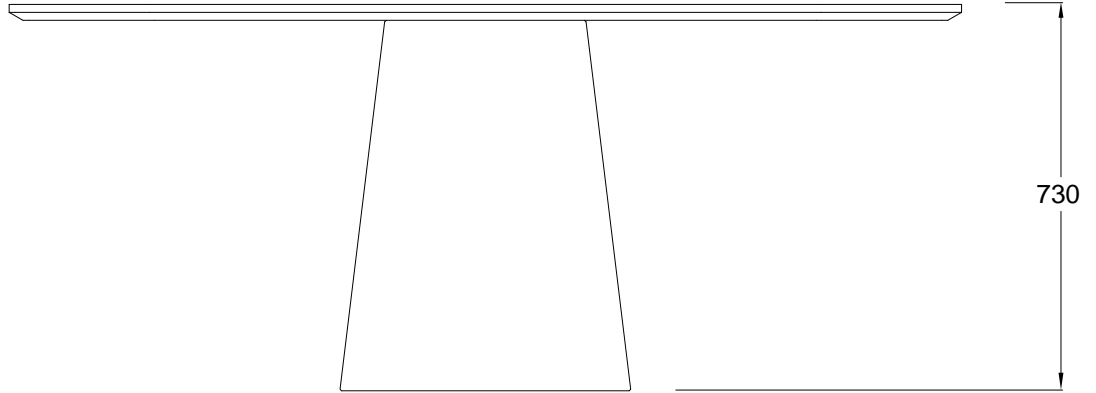
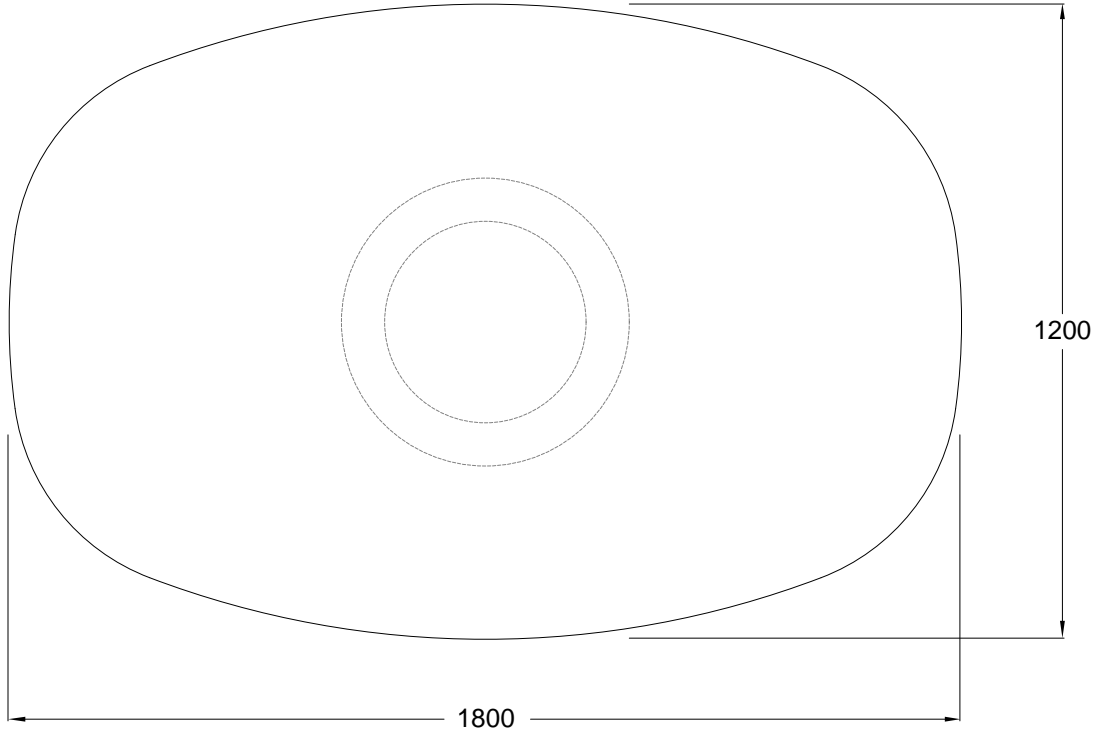

LIQUEUR TABLE

LQ_TB.210x120

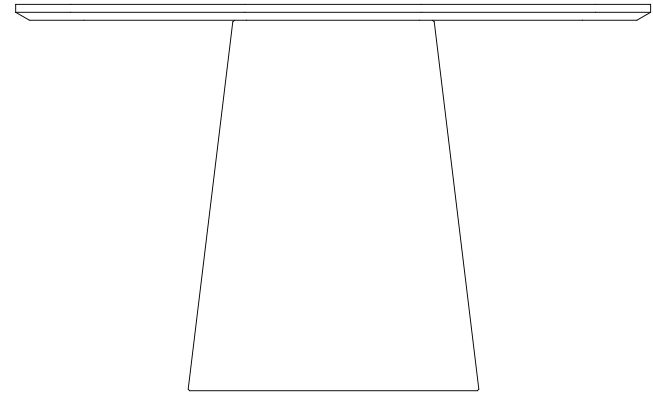
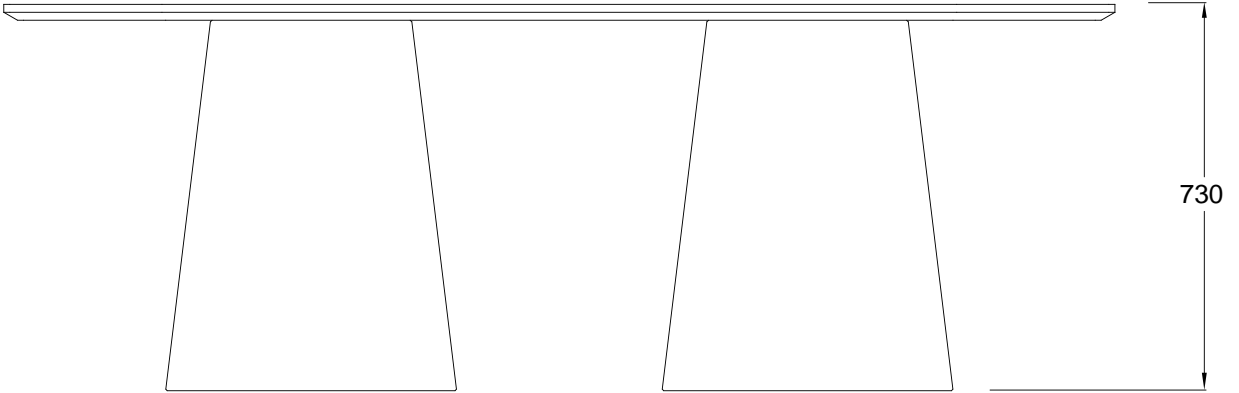
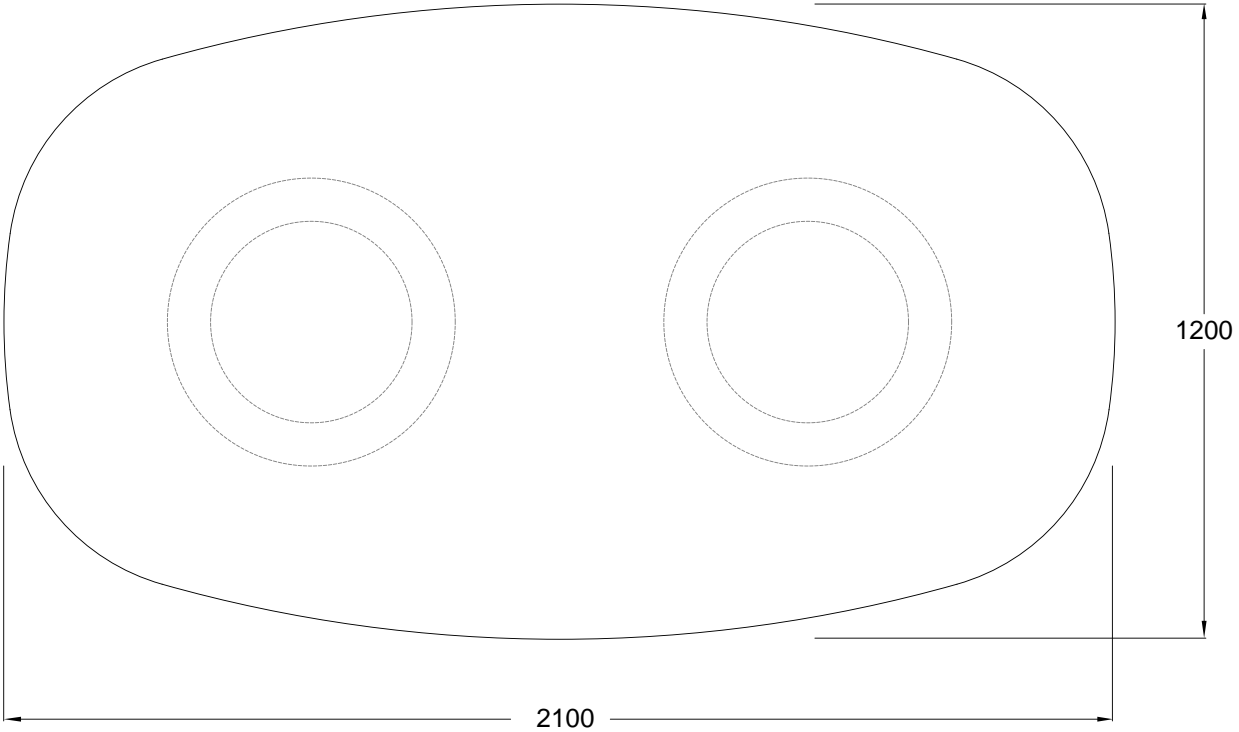

LIQUEUR TABLE

LQ_TB.240x120

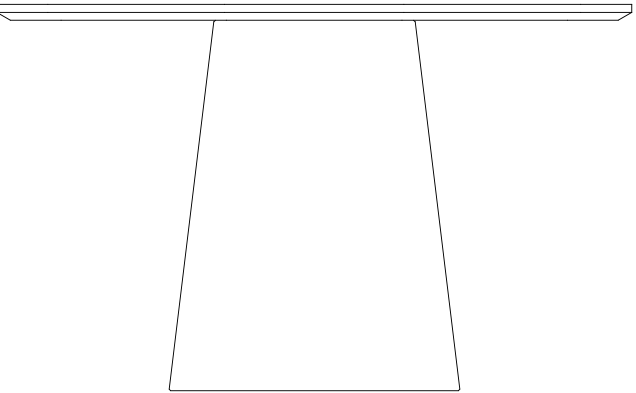
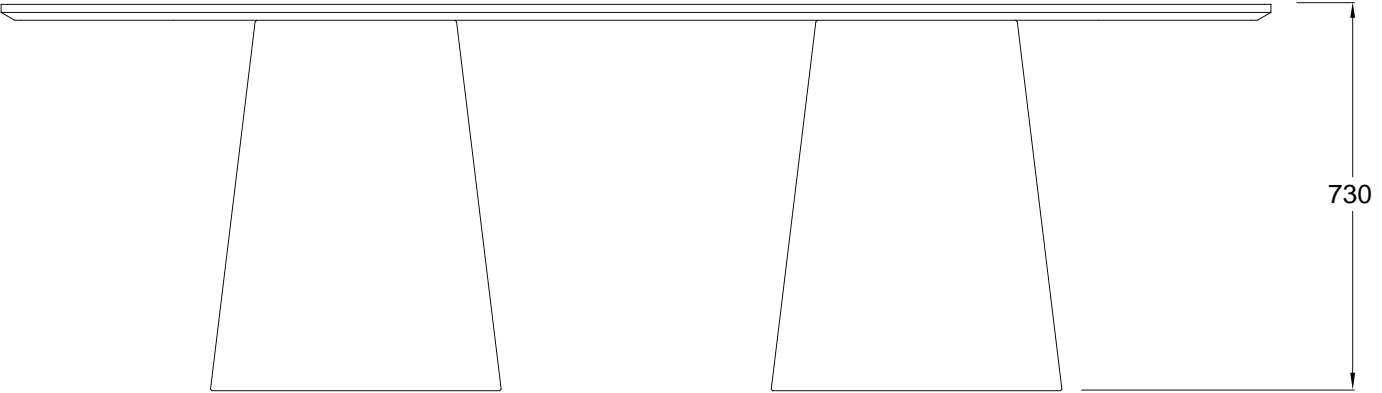
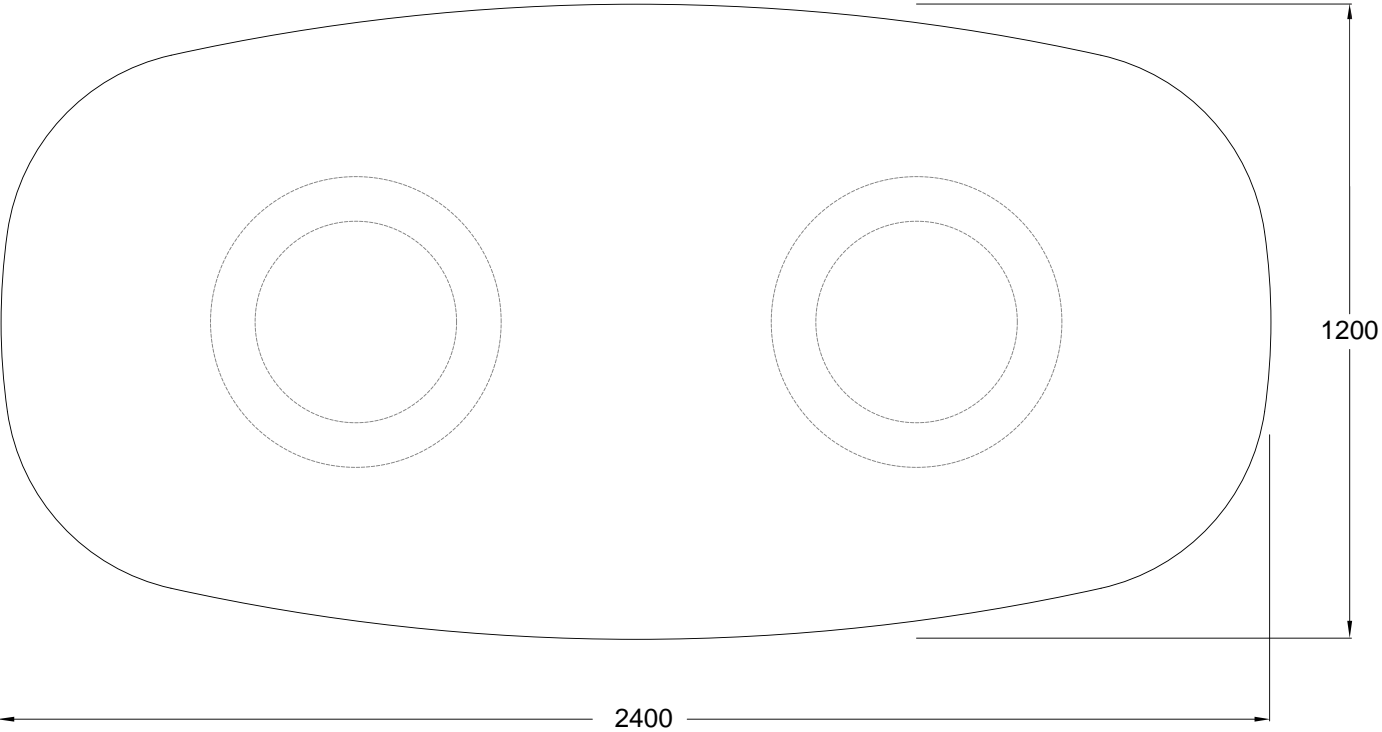

LIQUEUR TABLE

LQ_TB.270x120

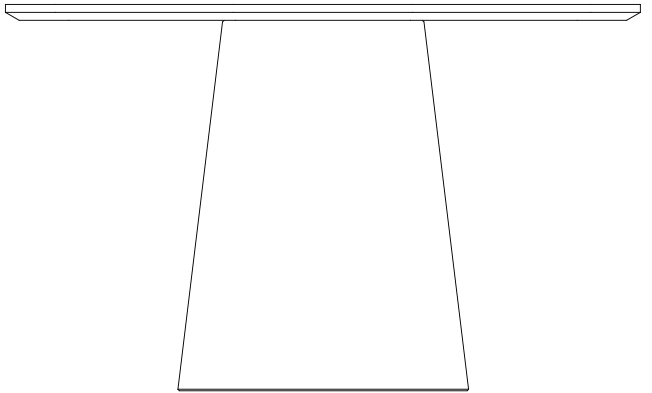
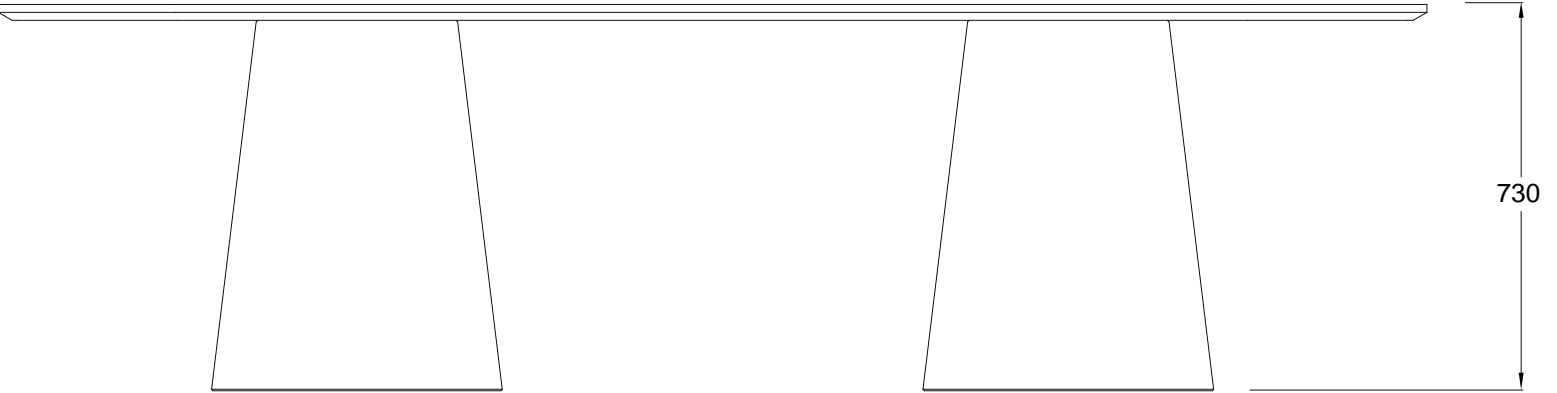
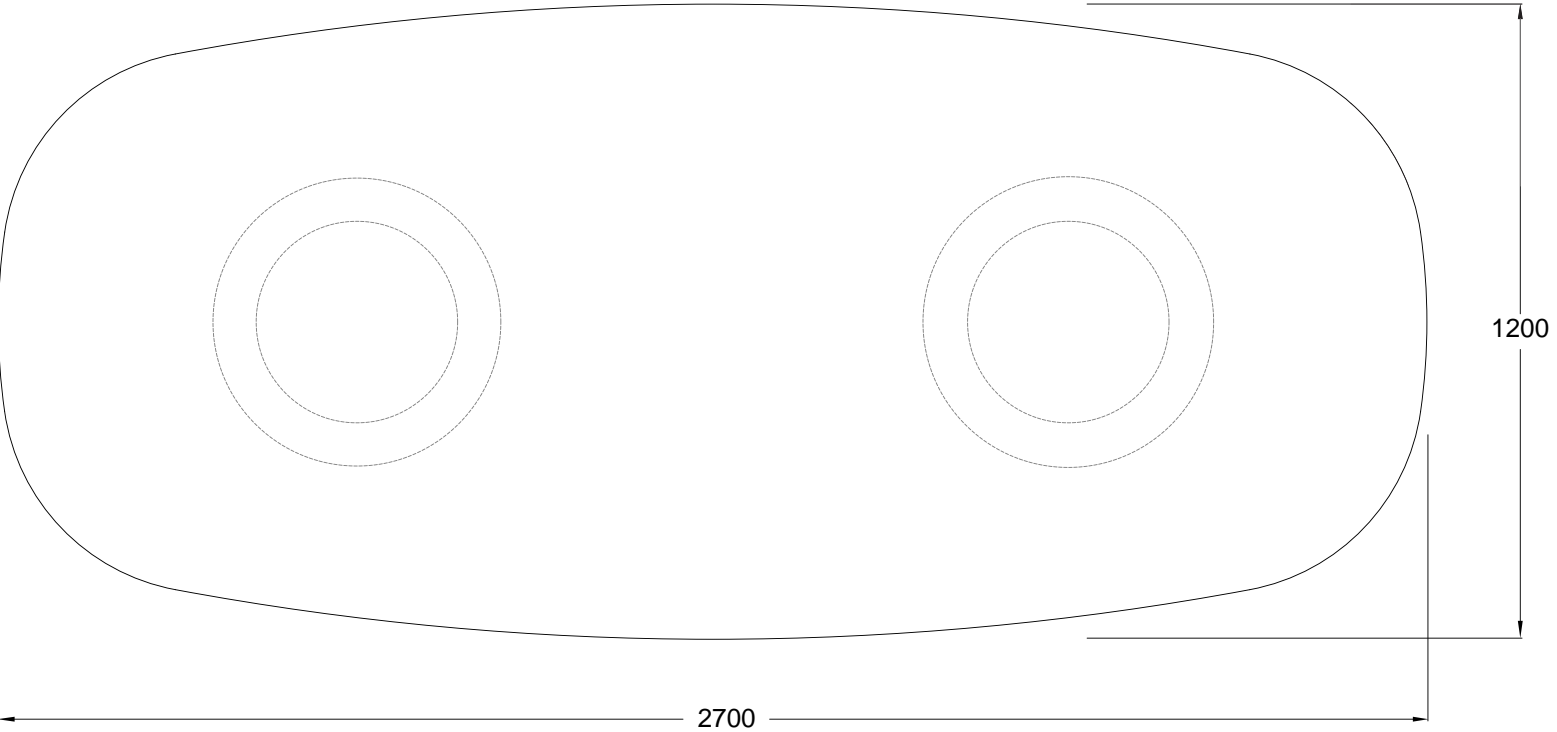

LIQUEUR TABLE

LQ_TB.300x120

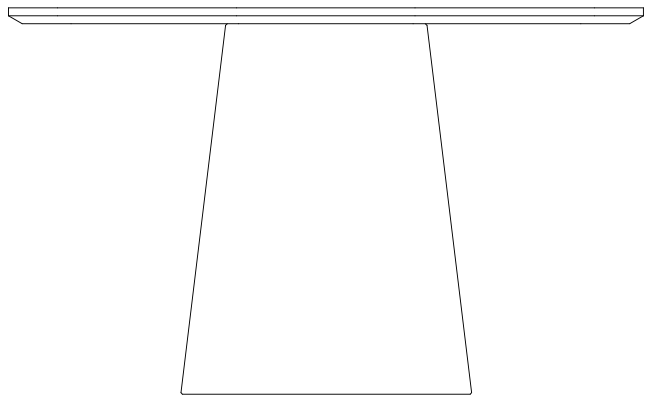
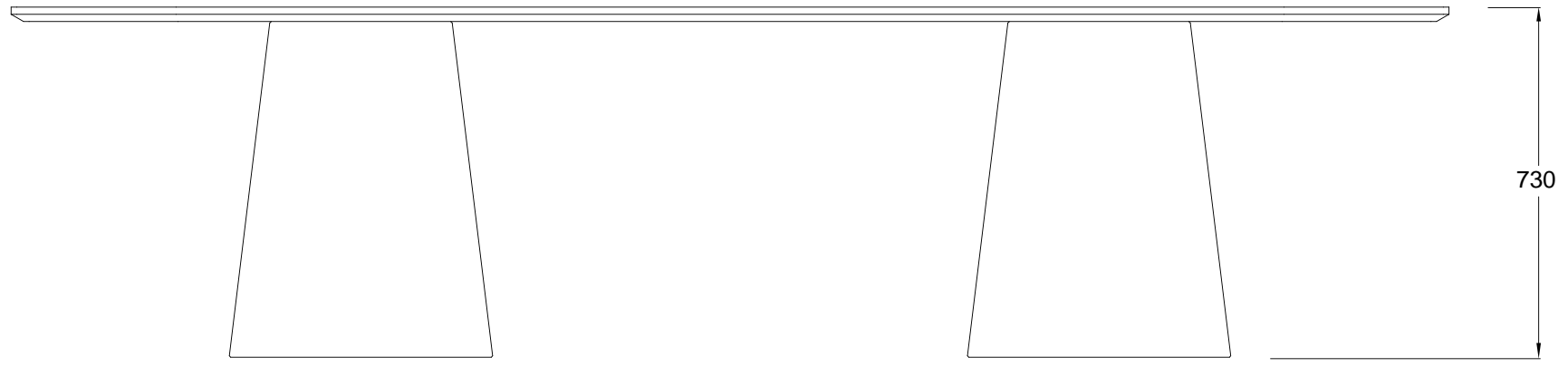
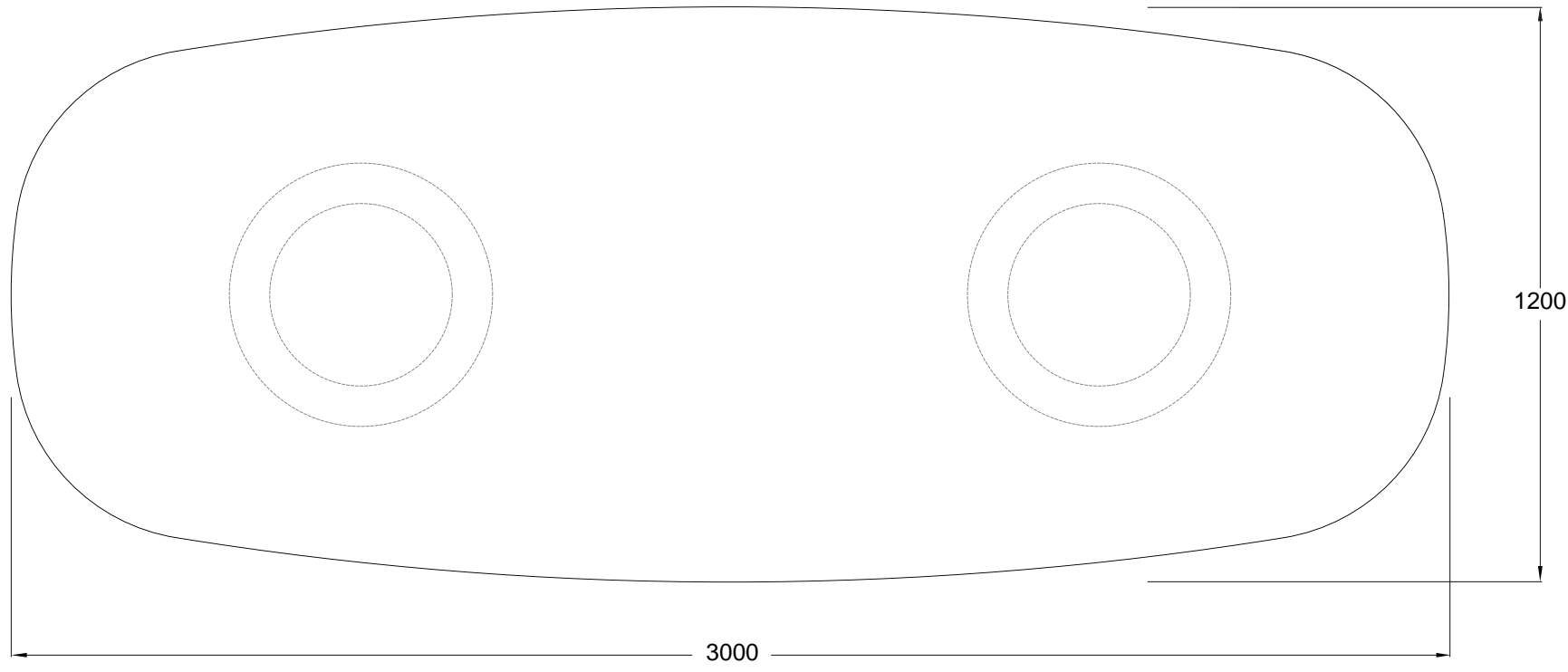

LIQUEUR TABLE

LQ_TB.330x120

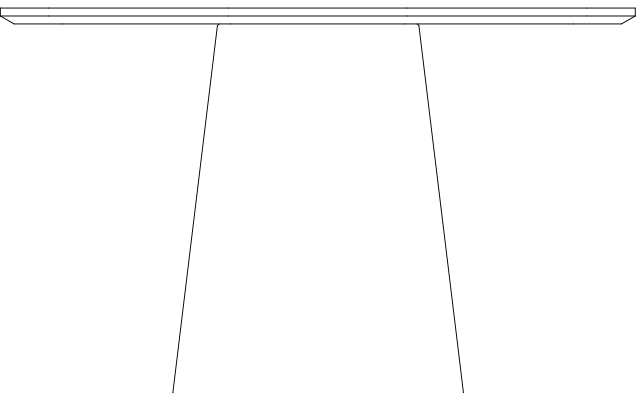
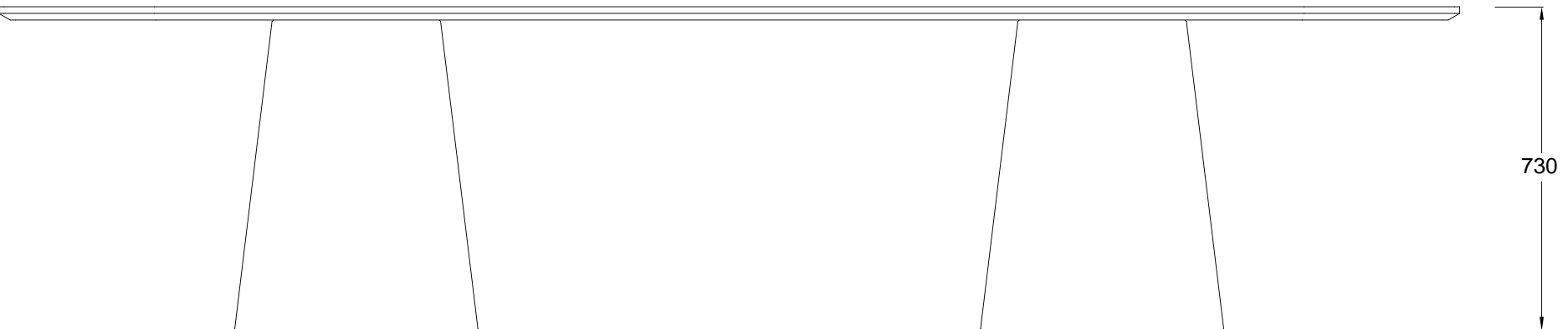
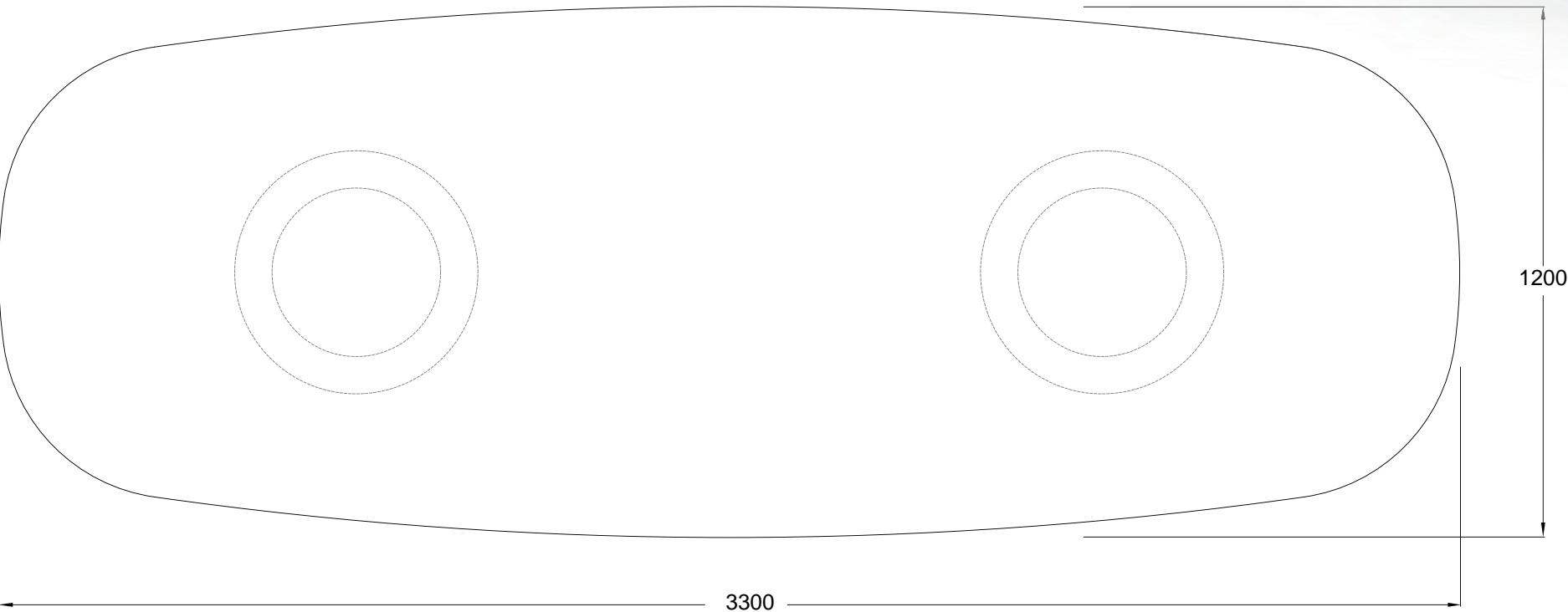

LIQUEUR TABLE

LQ_TB.360x120

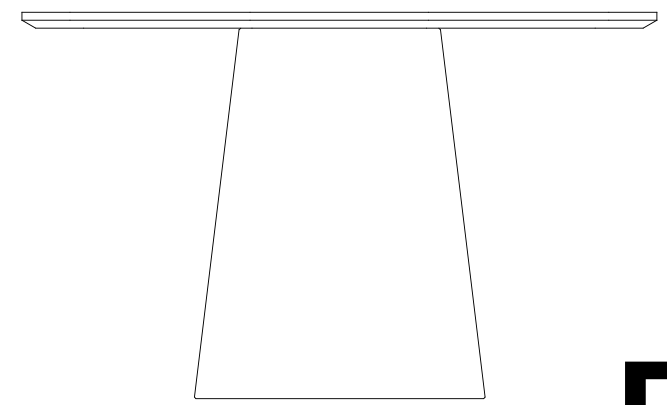
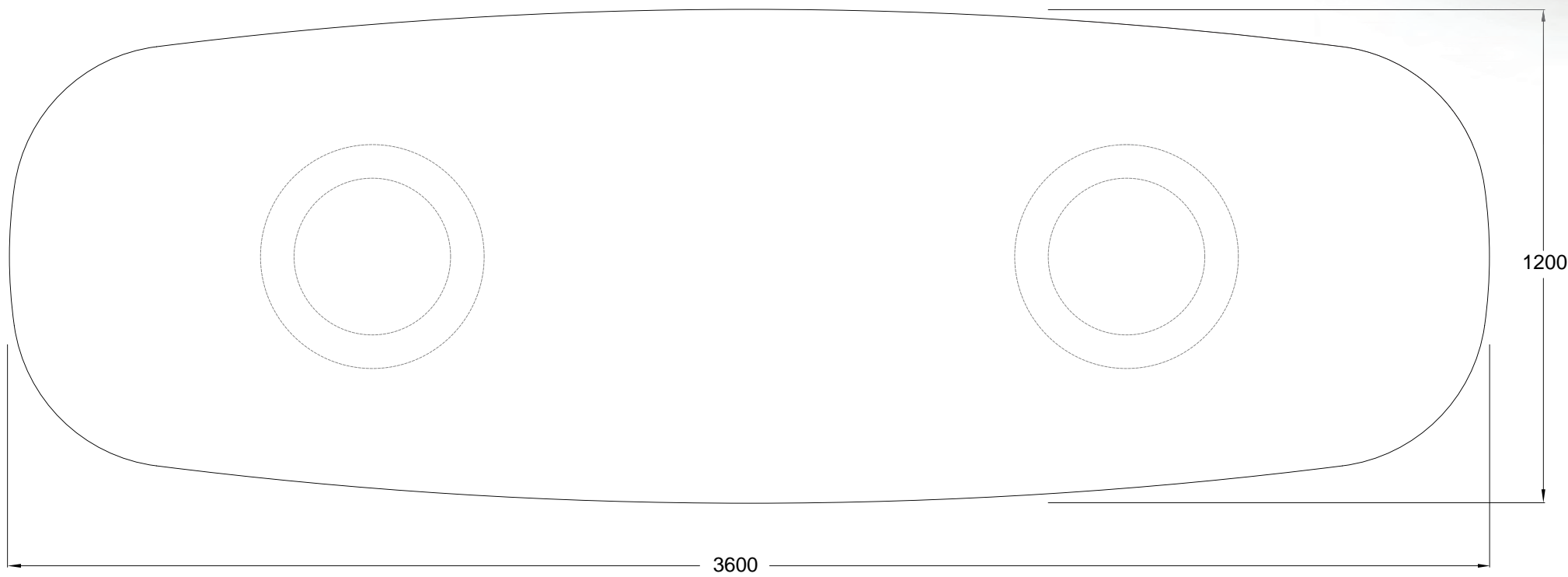

LIQUEUR TABLE

LQ_TB.270x135

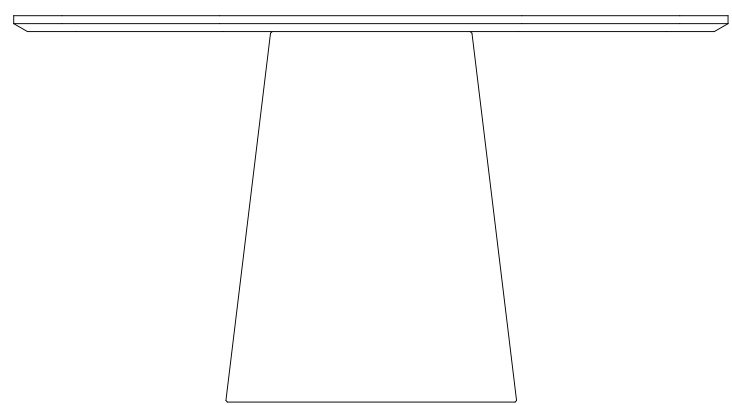
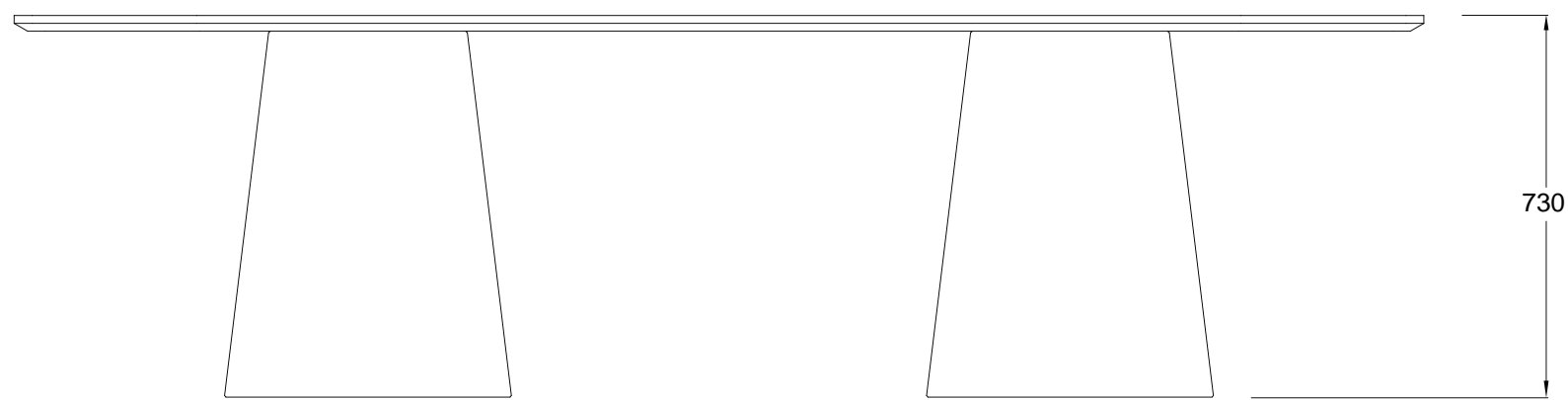
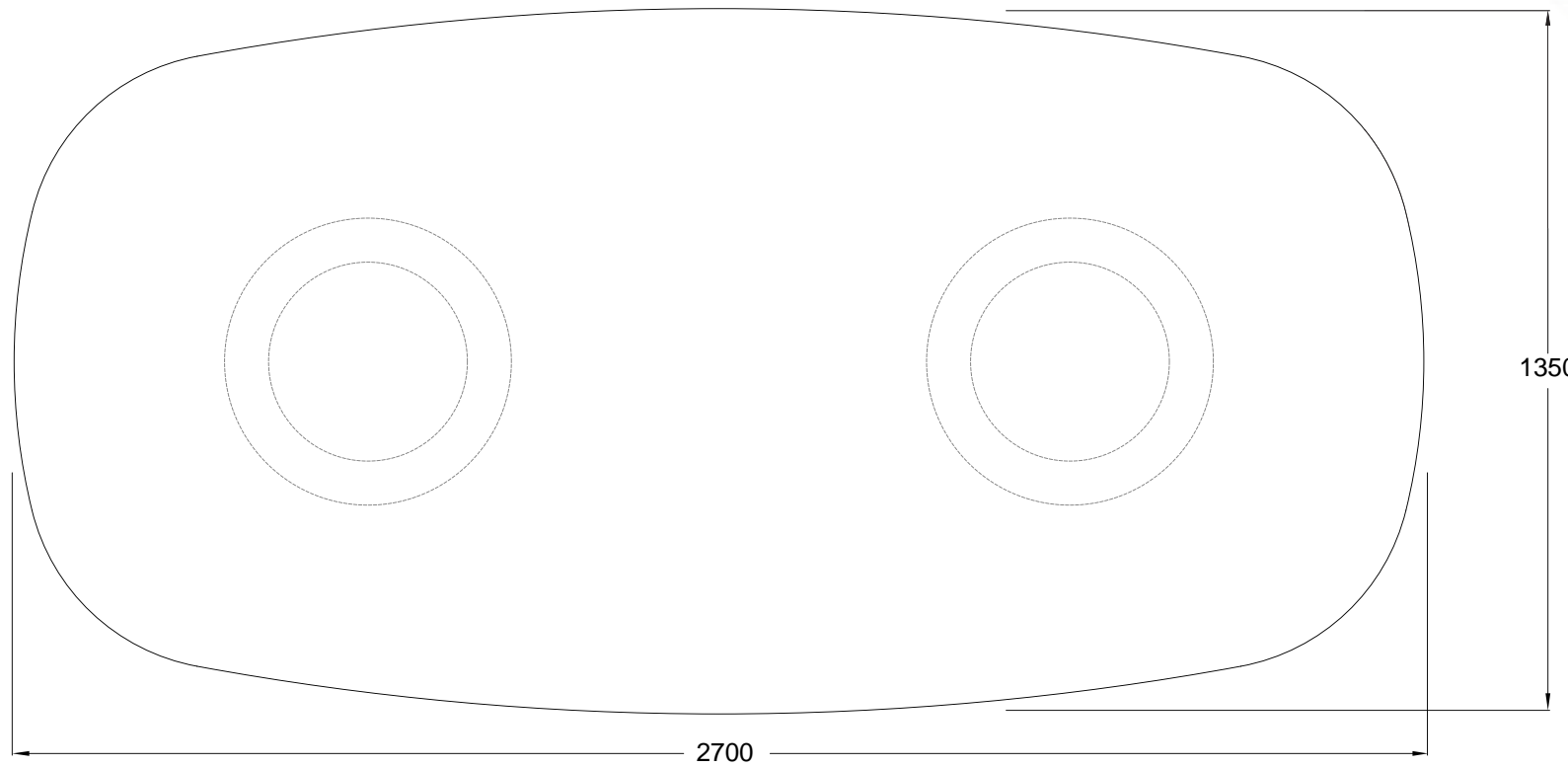

LIQUEUR TABLE

LQ_TB.300x135

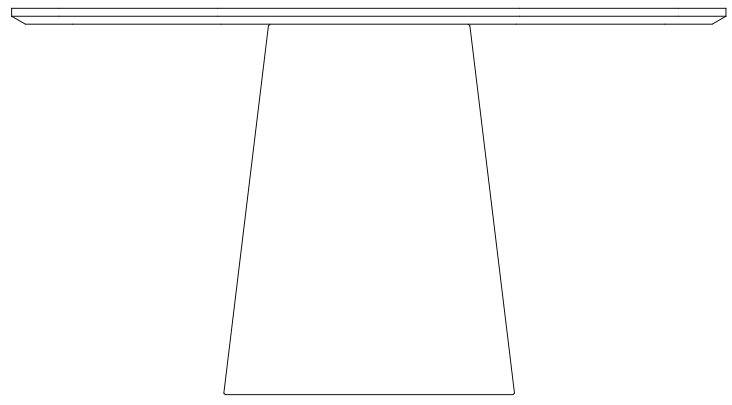
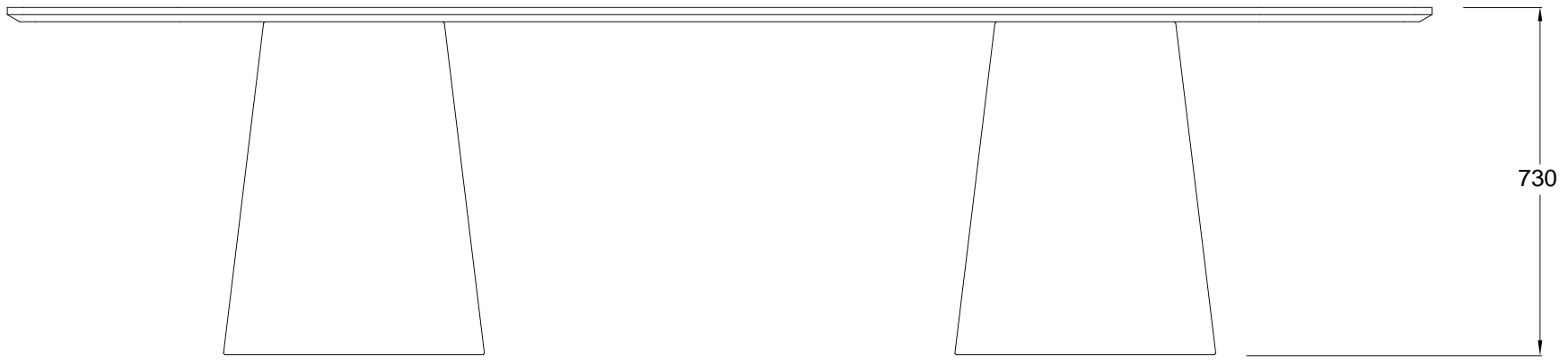
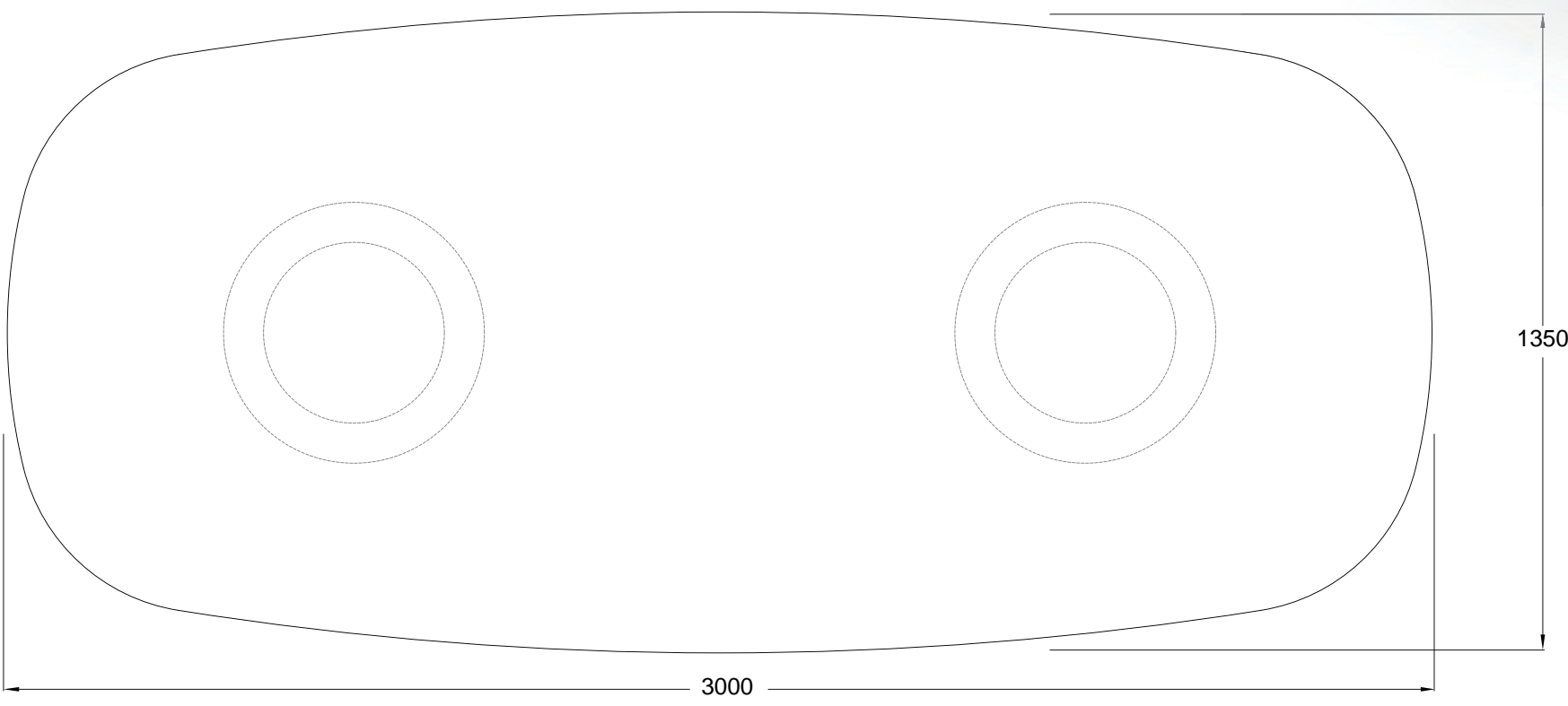

LIQUEUR TABLE

LQ_TB.330x135

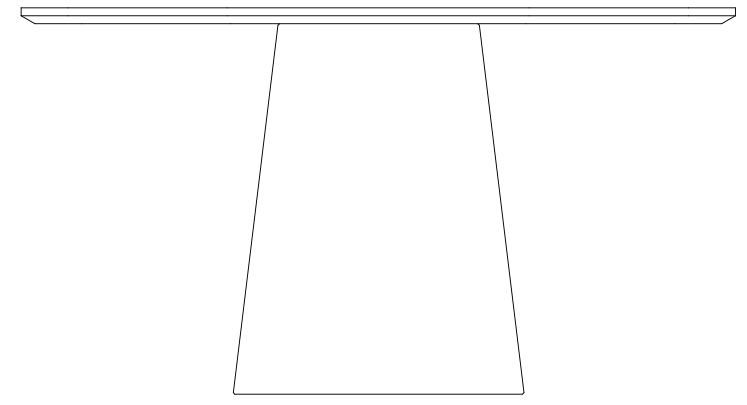
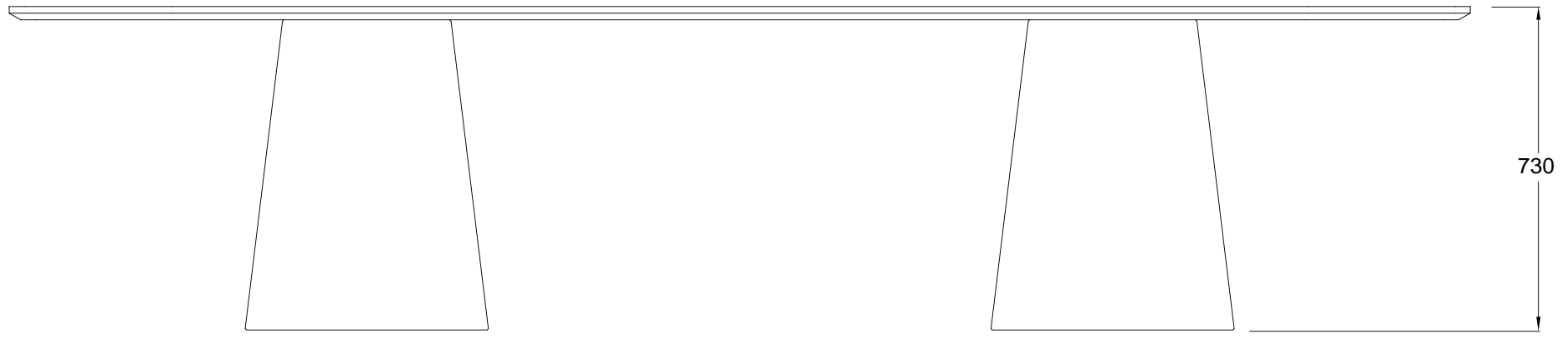
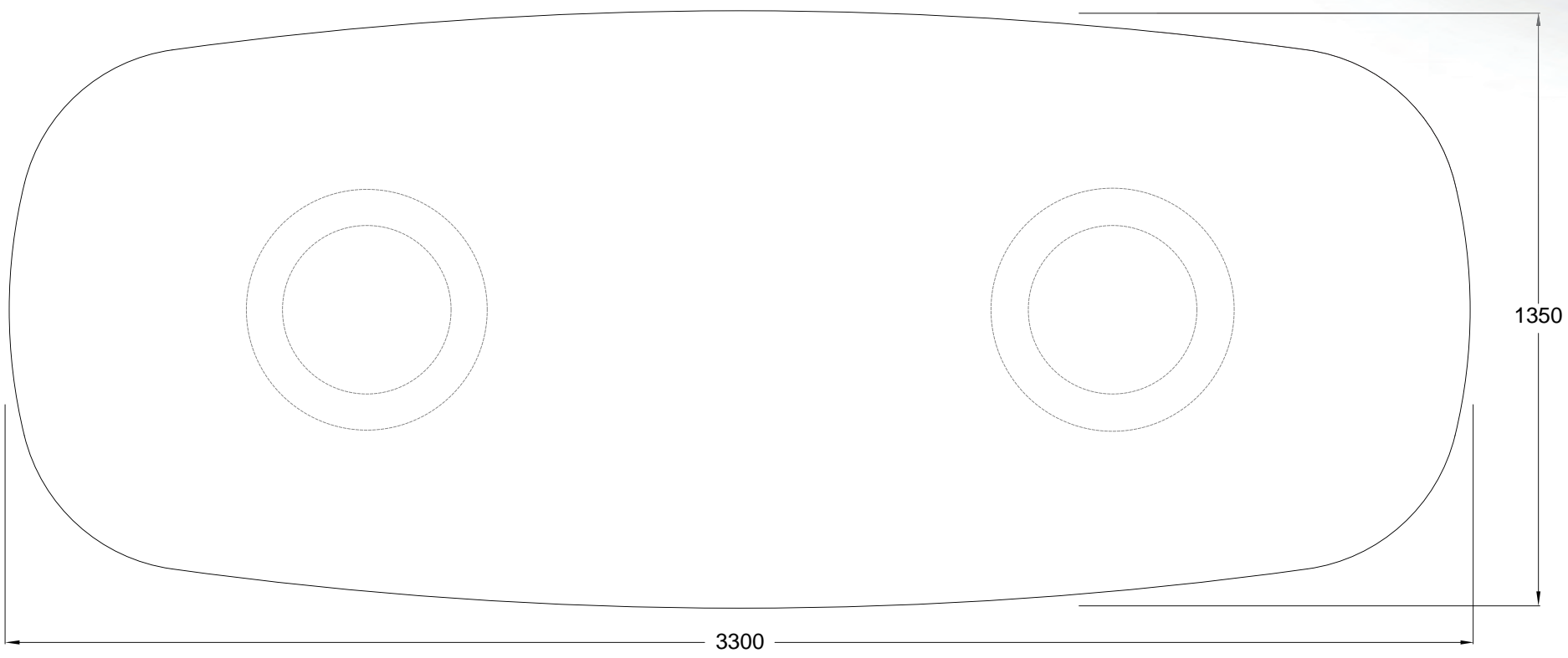

LIQUEUR TABLE

LQ_TB.360x135

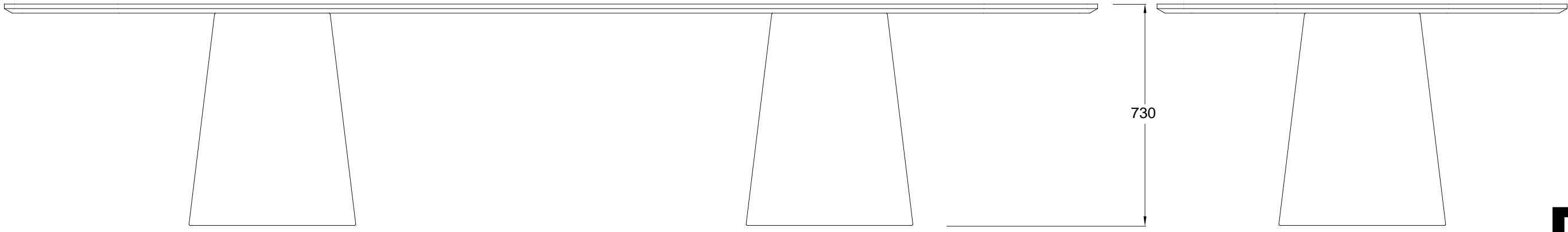
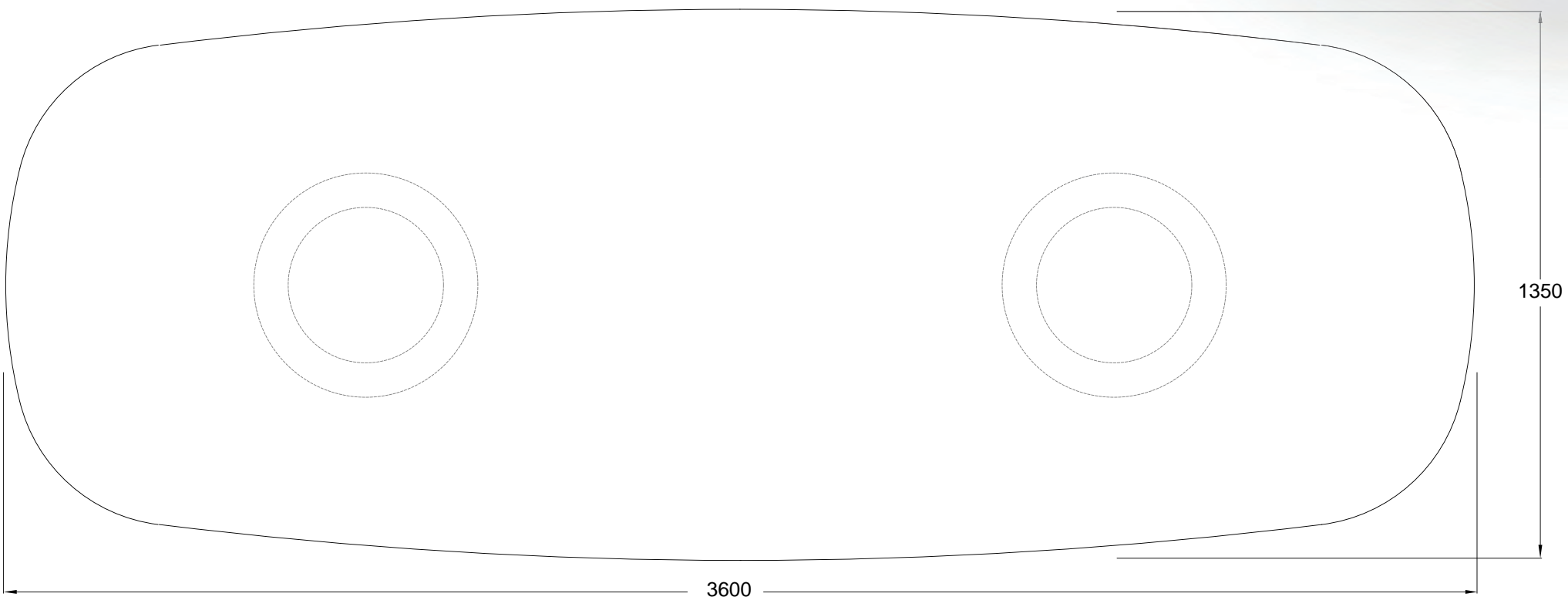

LIQUEUR TABLE

LQ_TB.180x90[RECT]

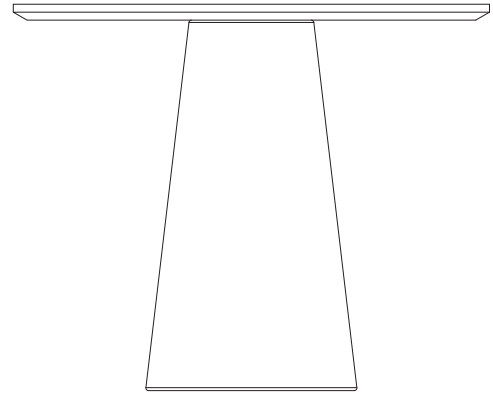
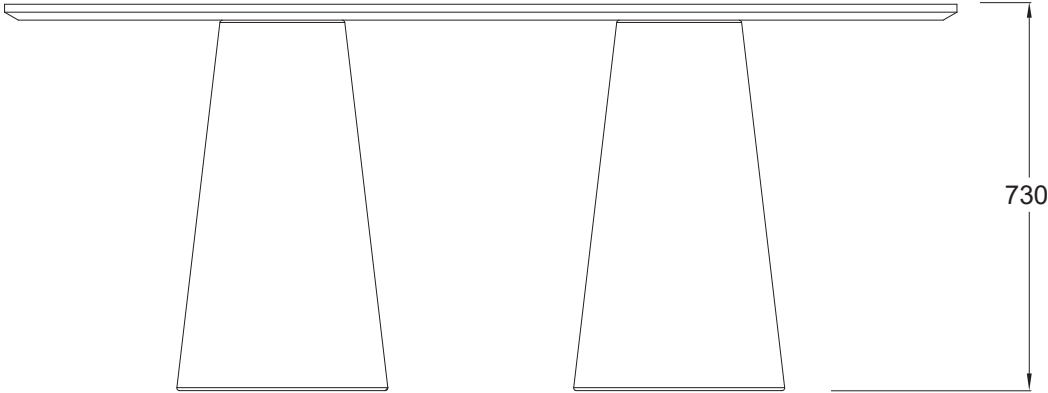
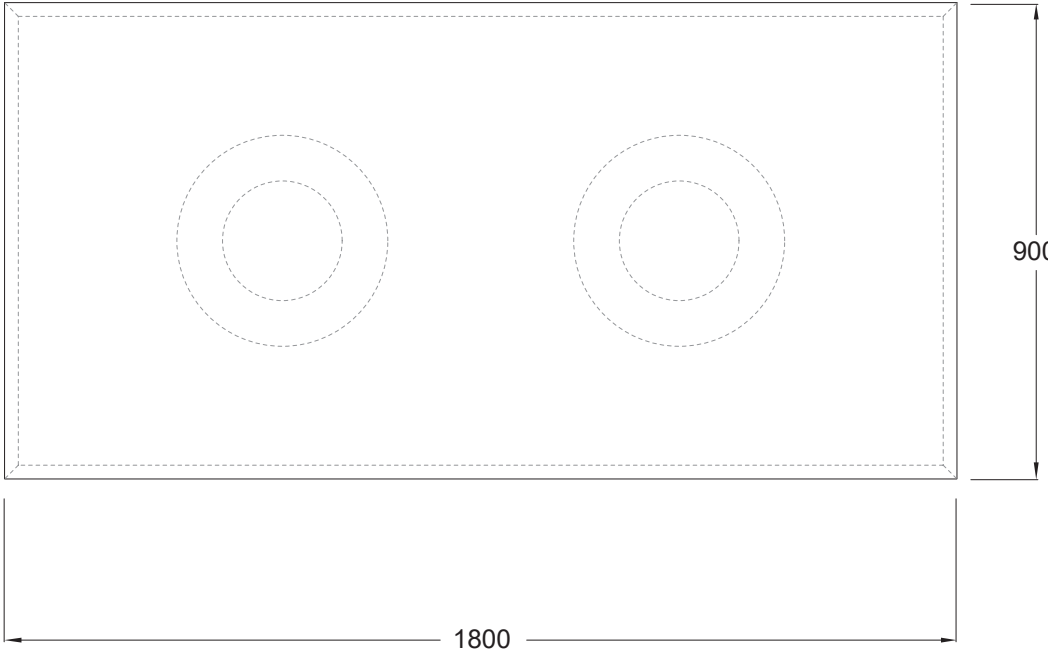

LIQUEUR TABLE

LQ_TB.210x90[RECT]

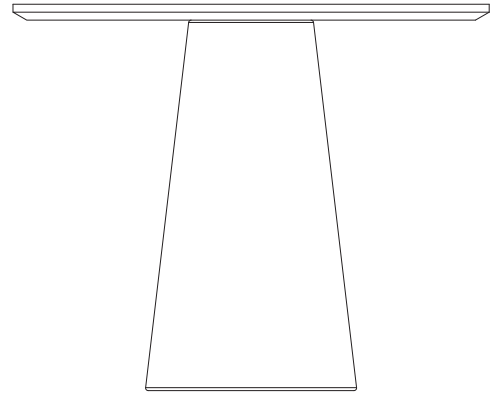
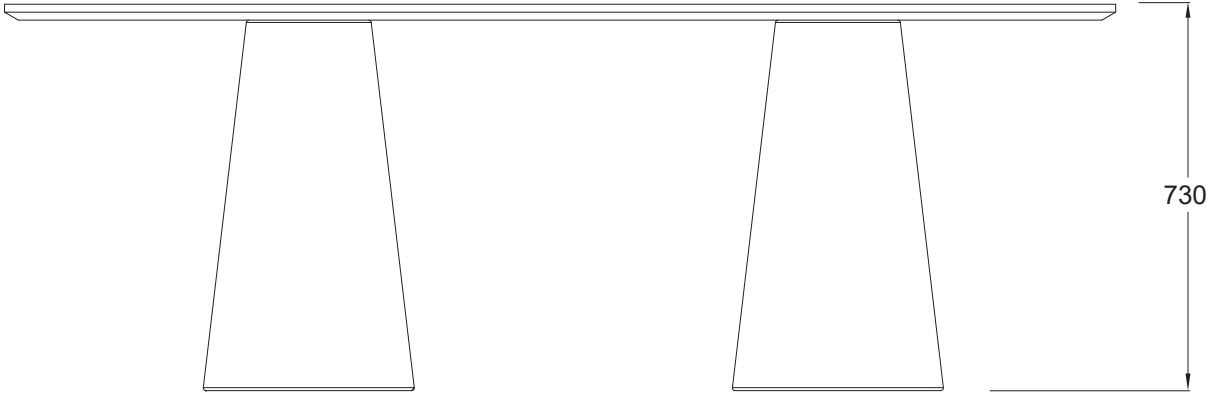
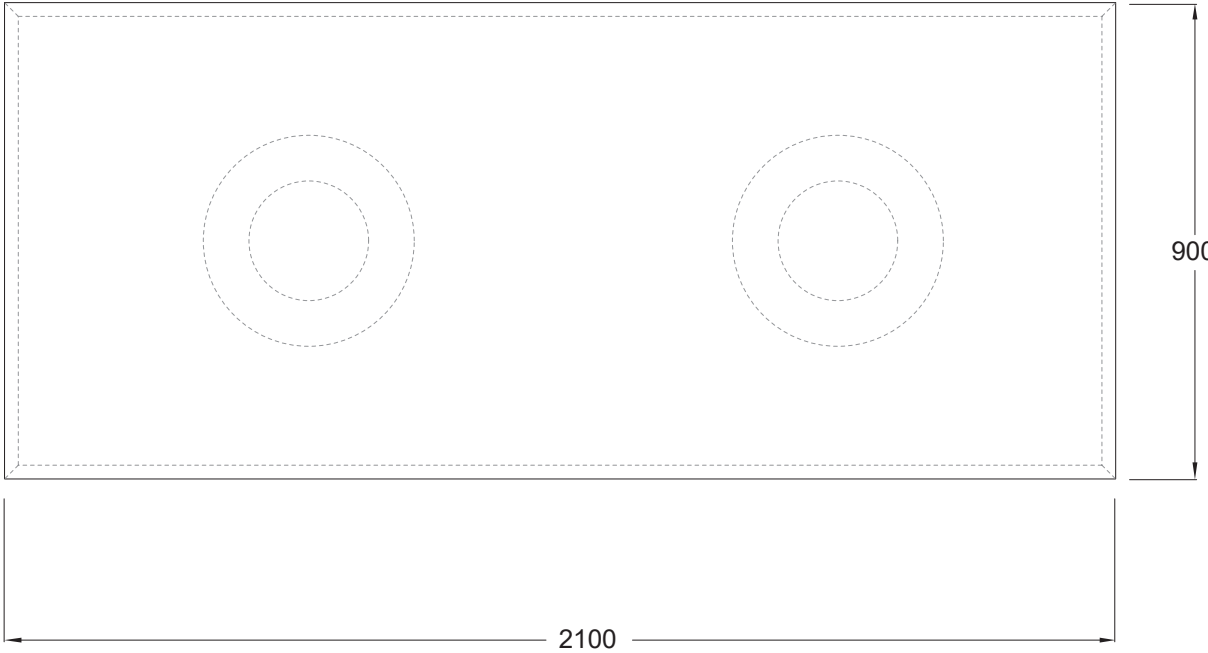

LIQUEUR TABLE

LQ_TB.240x90[RECT]

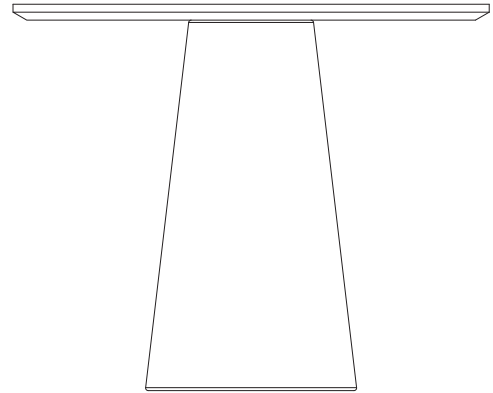
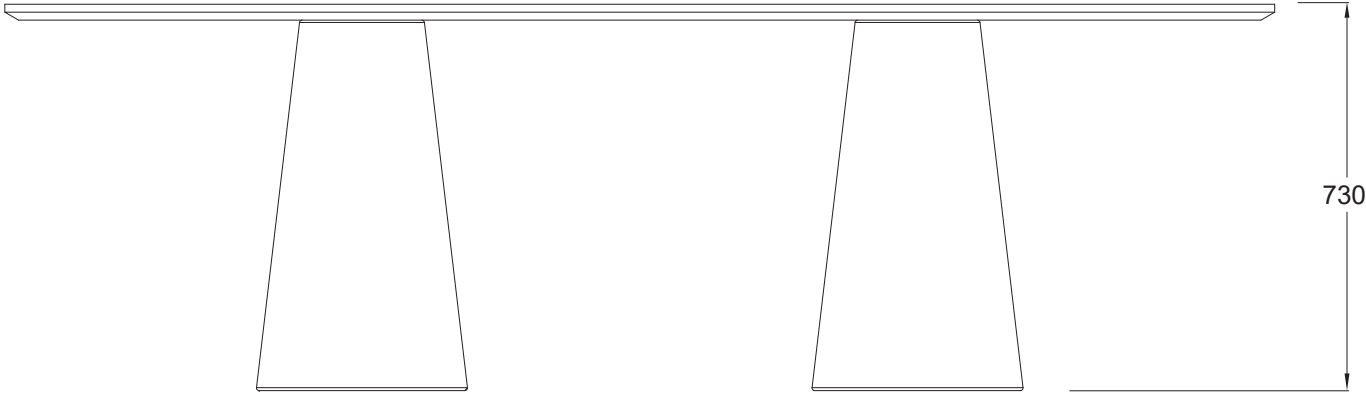
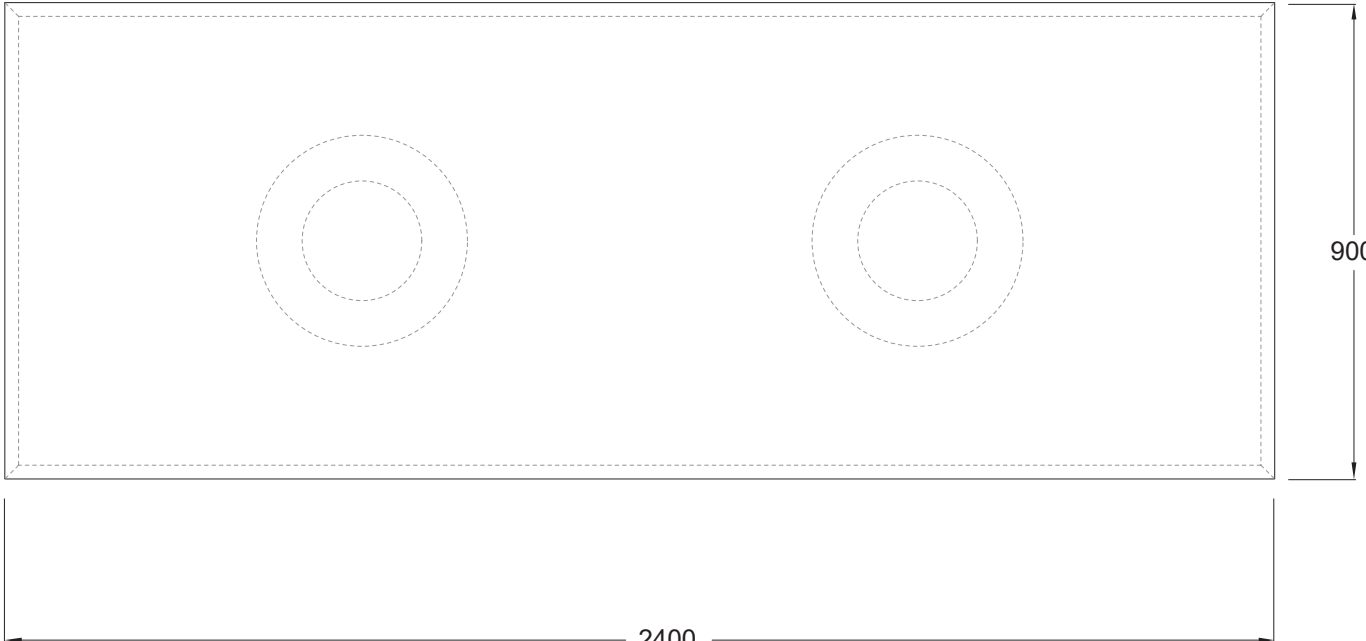

LIQUEUR TABLE

LQ_TB.270x90[RECT]

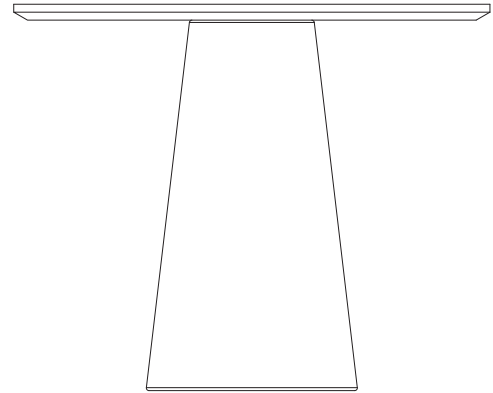
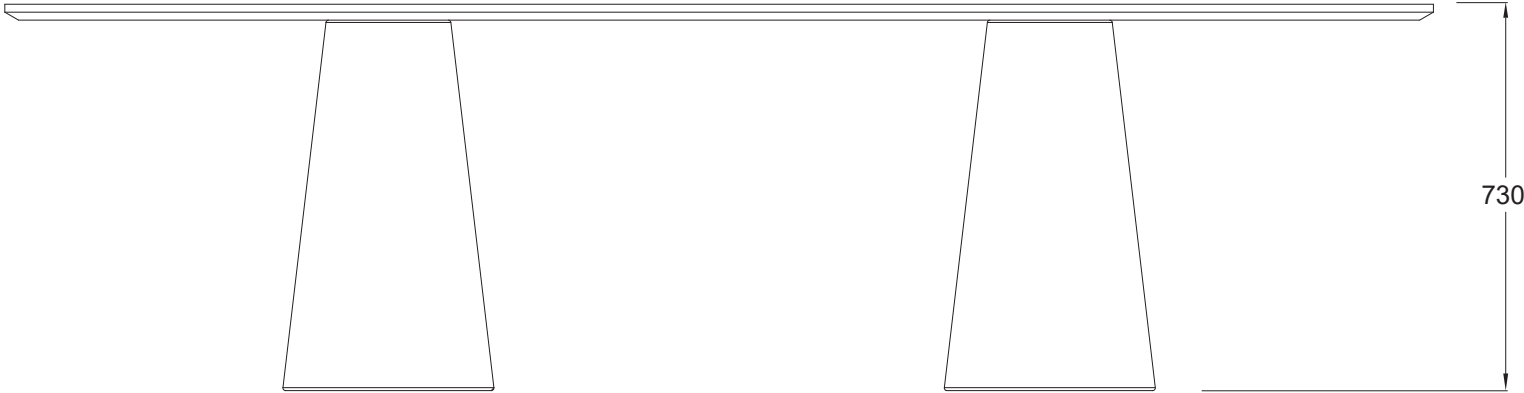
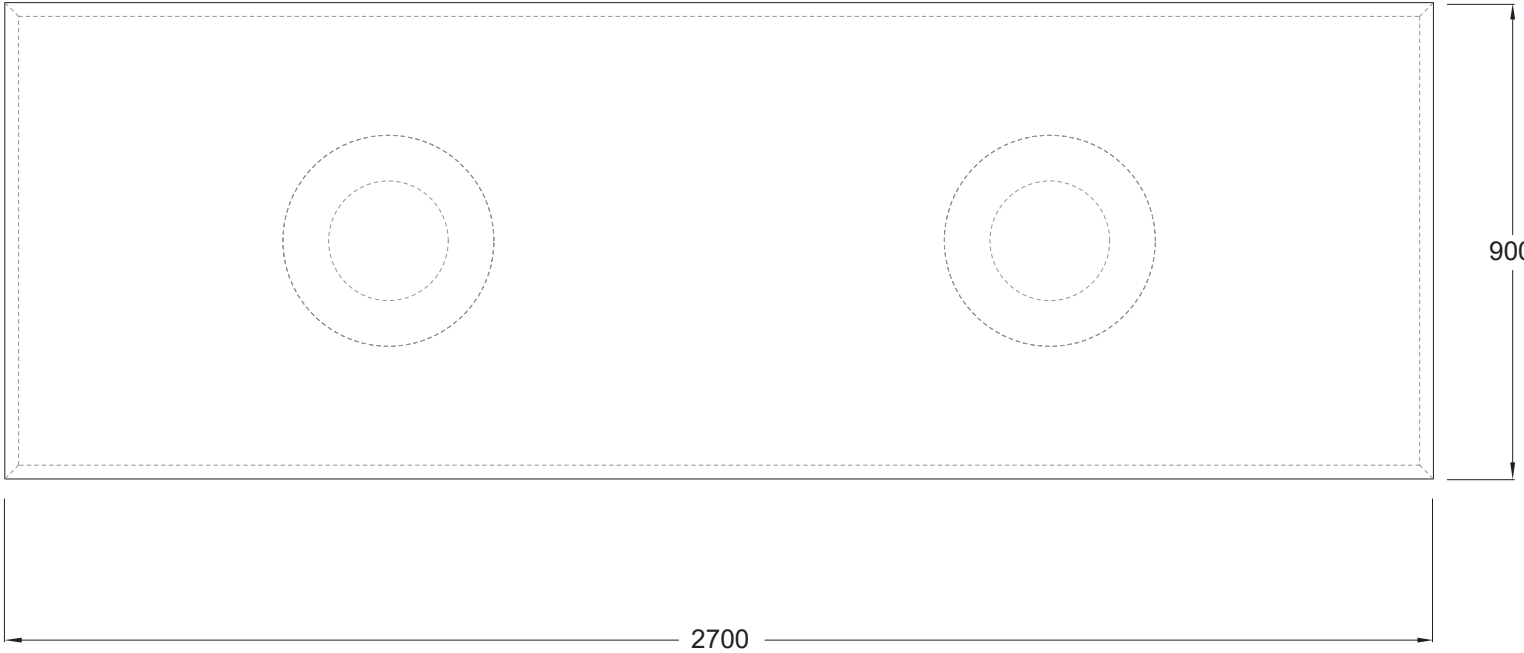

LIQUEUR TABLE [RECTANGLE]

LQ_TB.210x120[RECTANGLE]

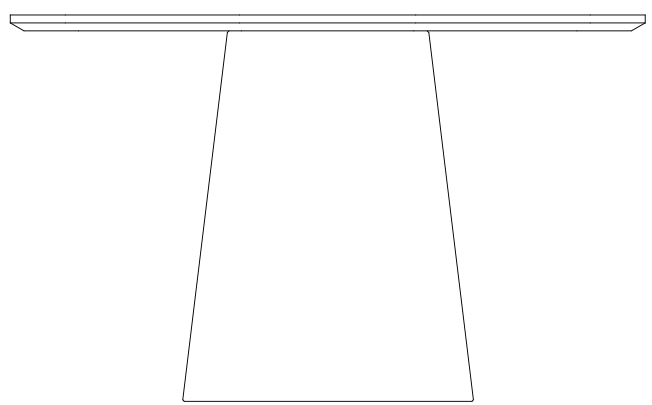
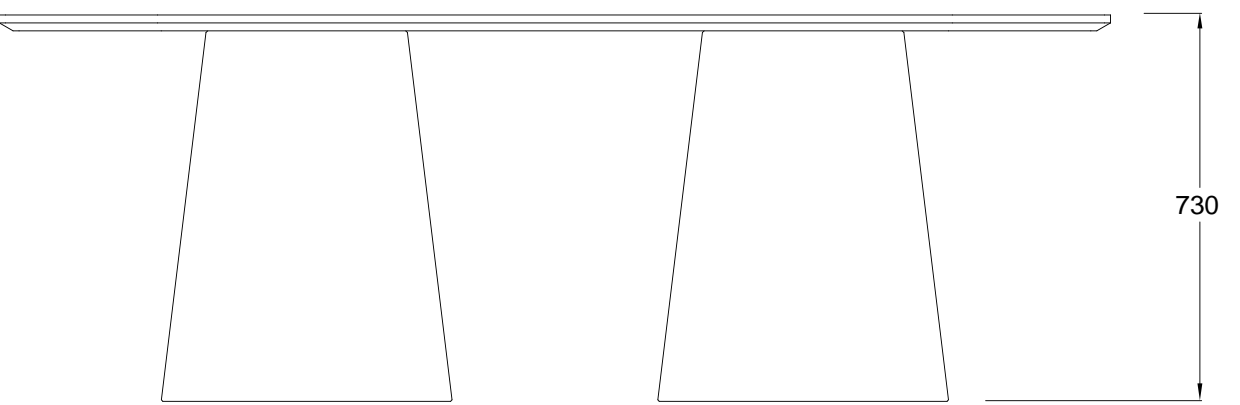
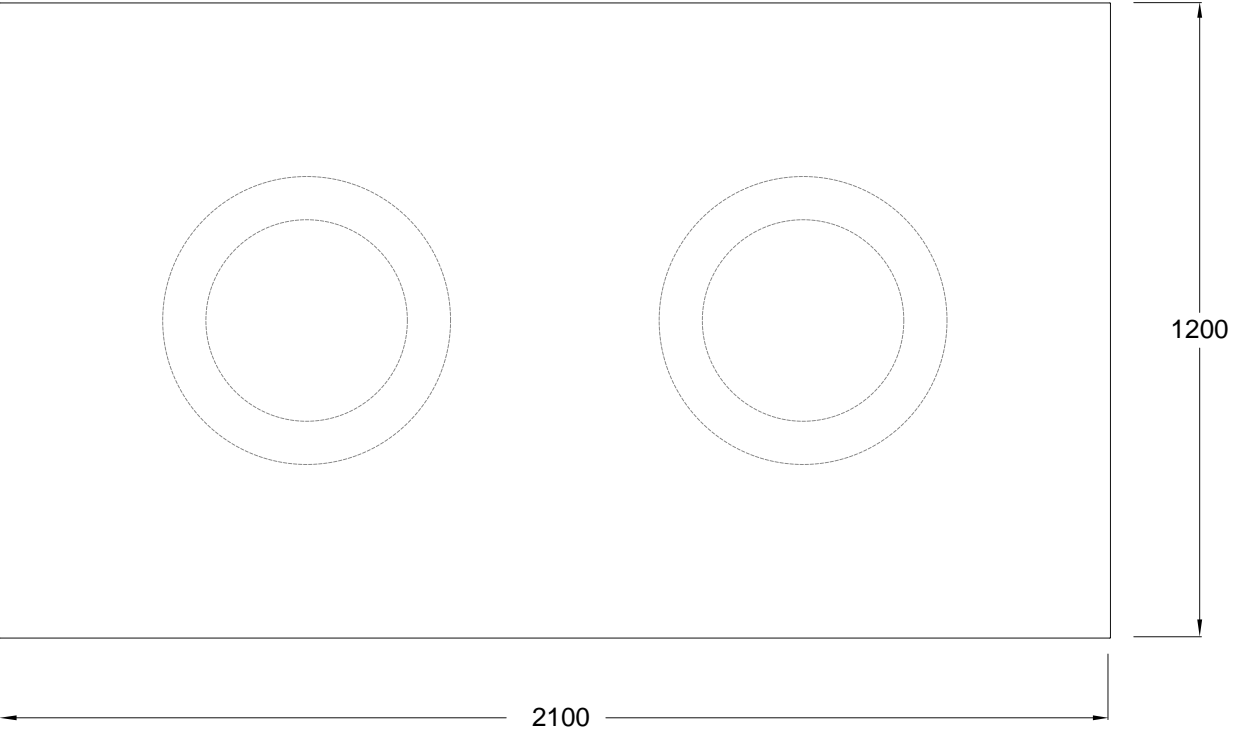

LIQUEUR TABLE [RECTANGLE]

LQ_TB.240x120[RECTANGLE]

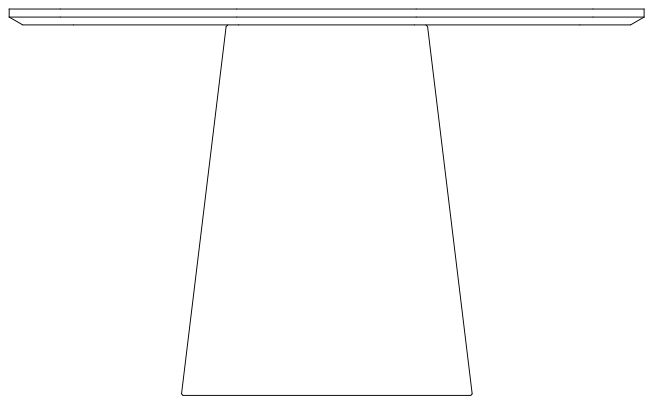
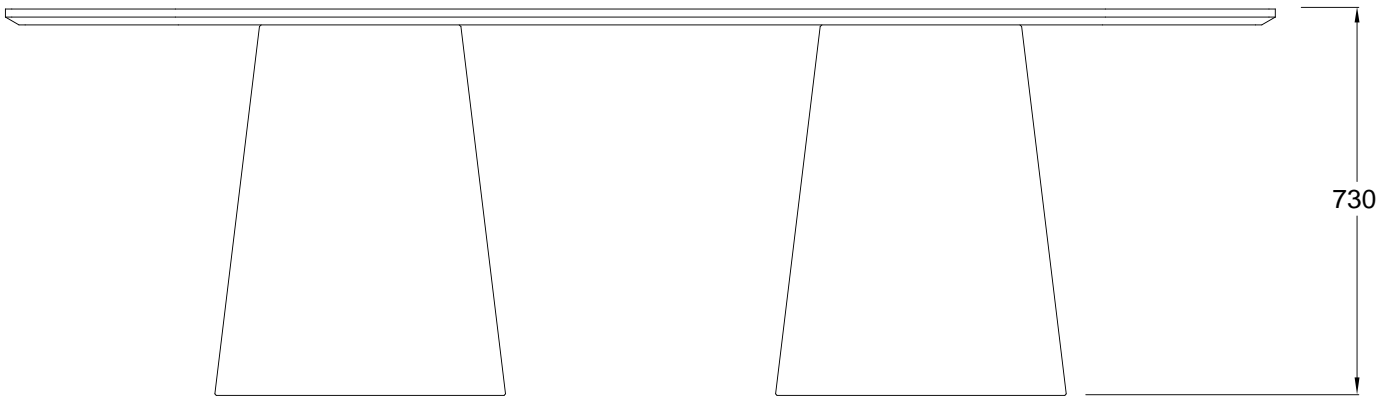
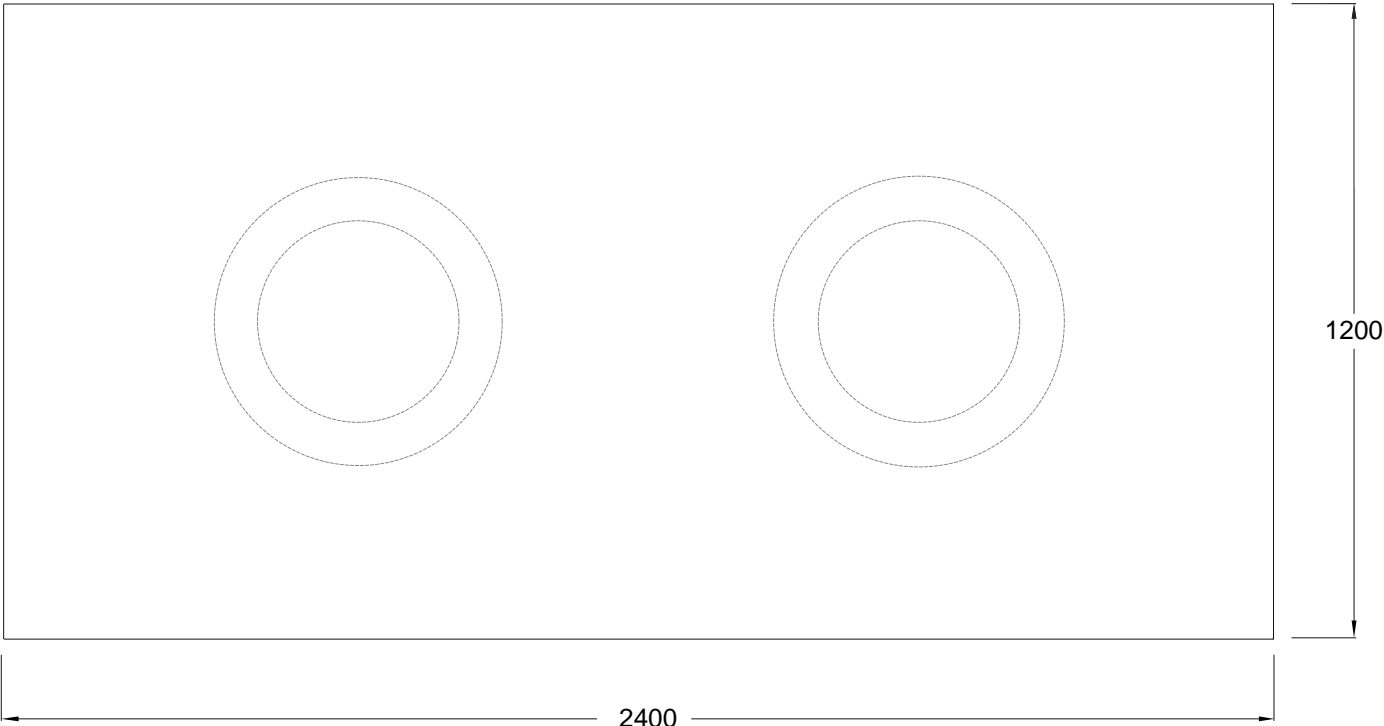

LIQUEUR TABLE [RECTANGLE]

LQ_TB.270x120[RECTANGLE]

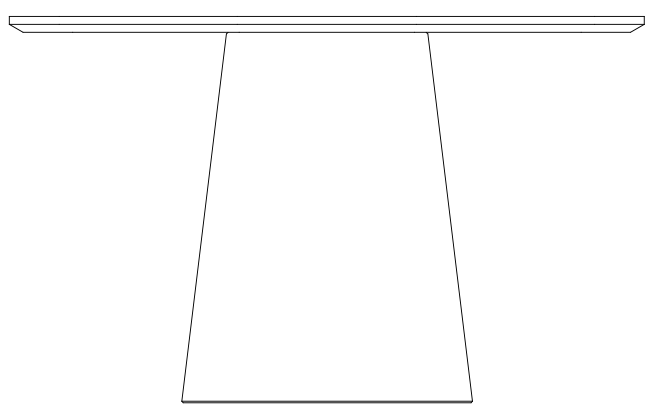
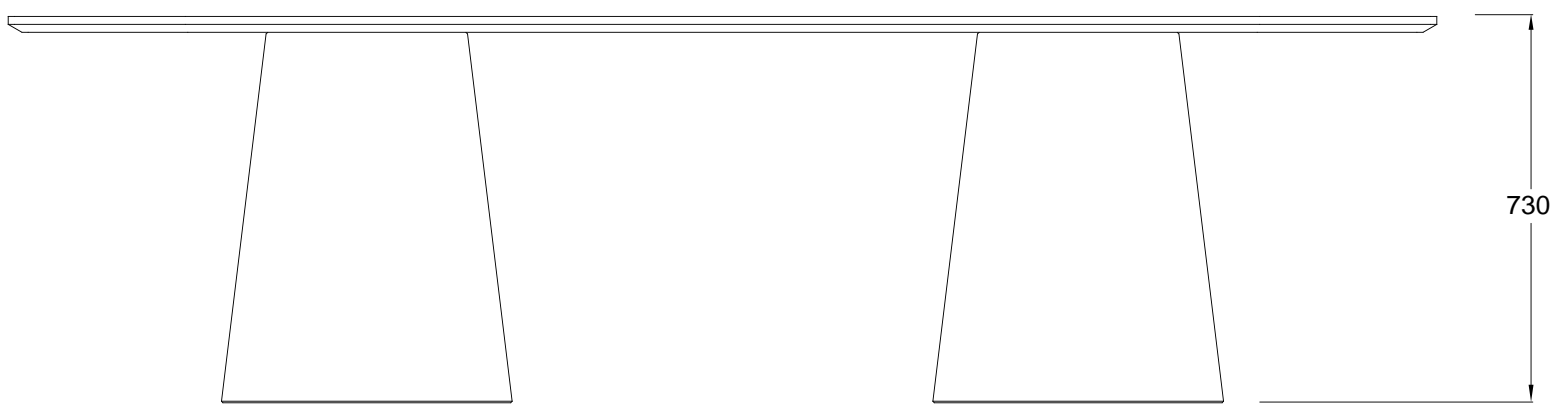
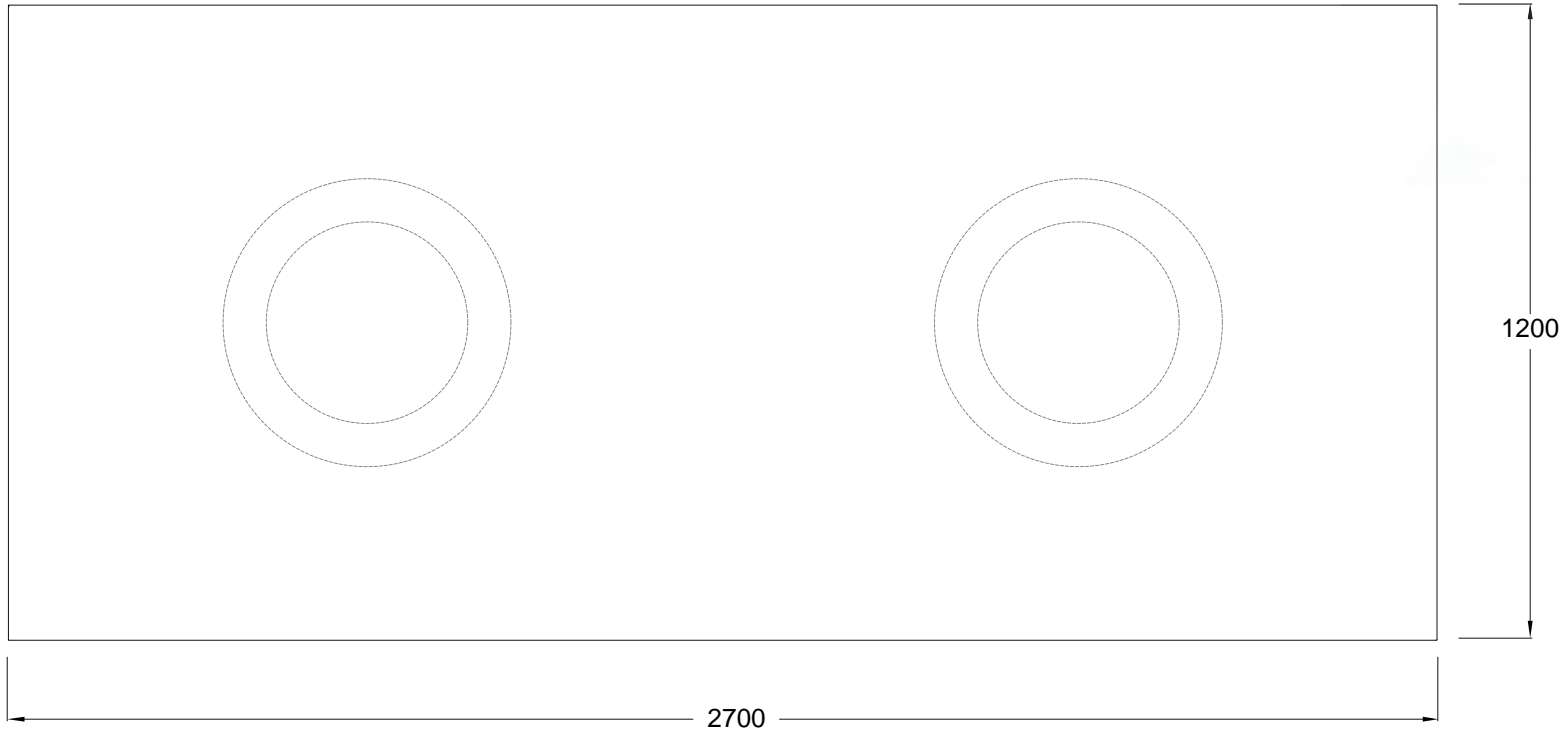

LIQUEUR TABLE [RECTANGLE]

LQ_TB.300x120[RECTANGLE]

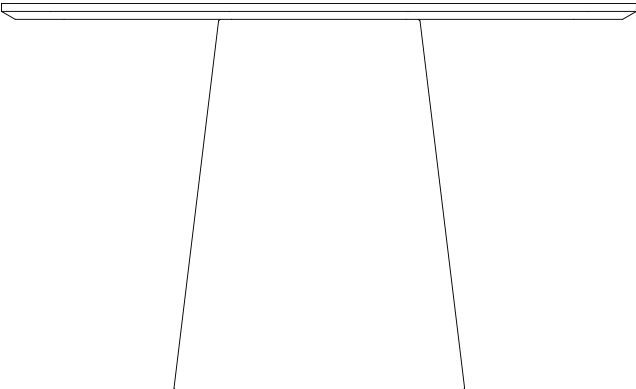
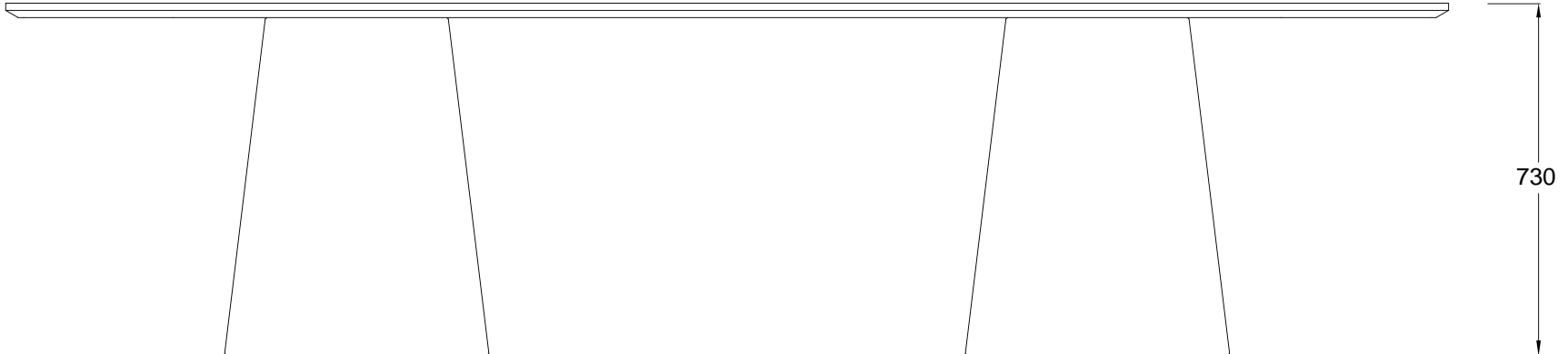
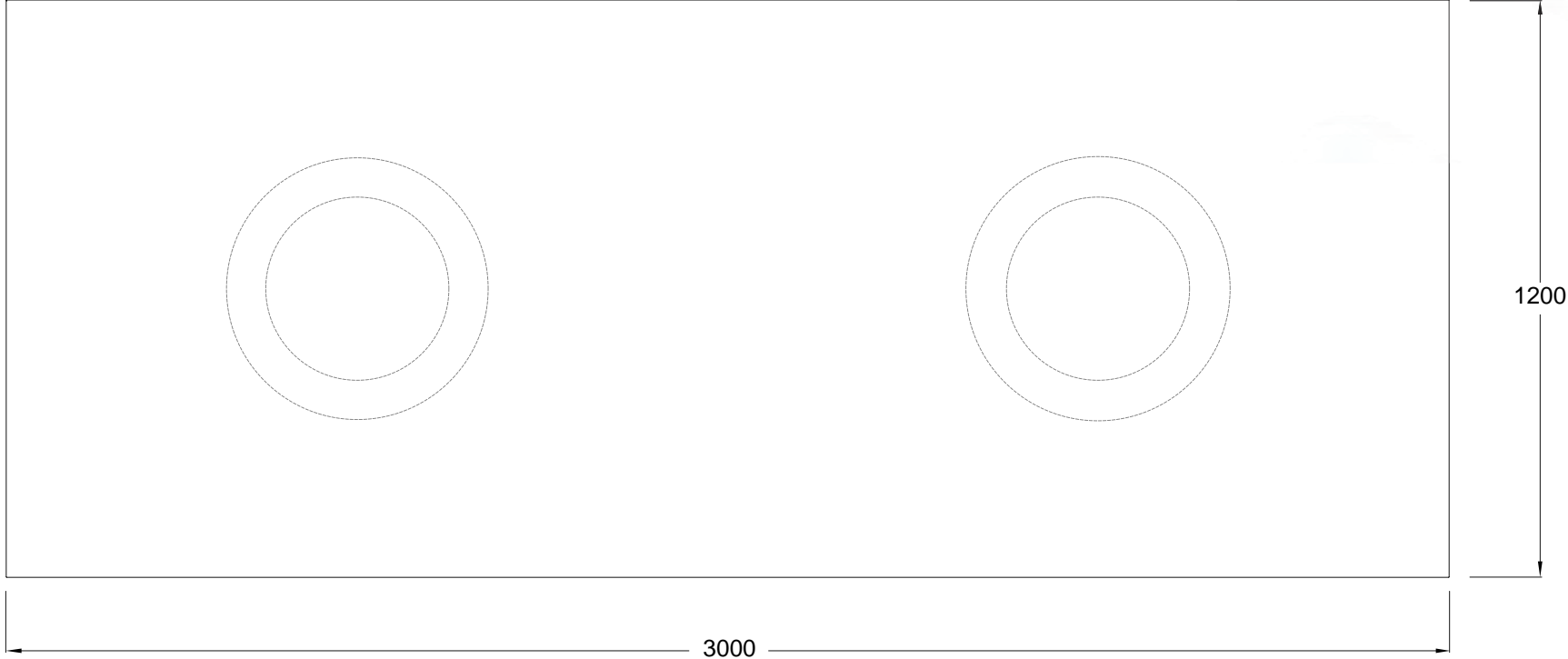

LIQUEUR TABLE [RECTANGLE]

LQ_TB.330x120[RECTANGLE]

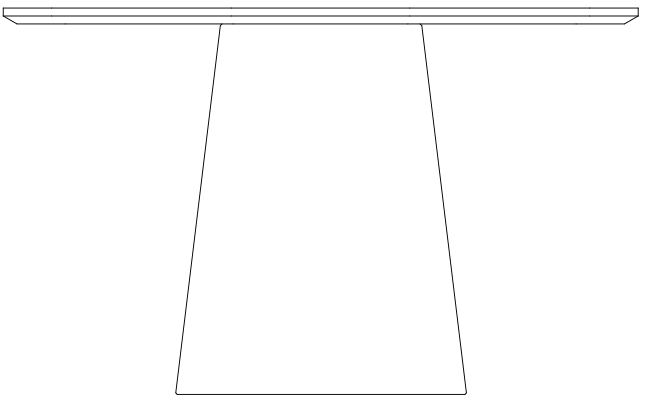
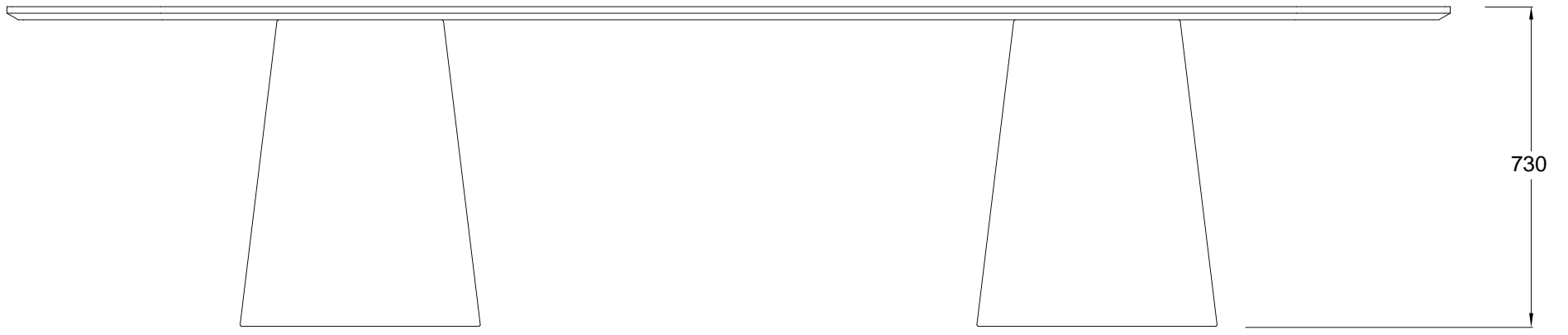
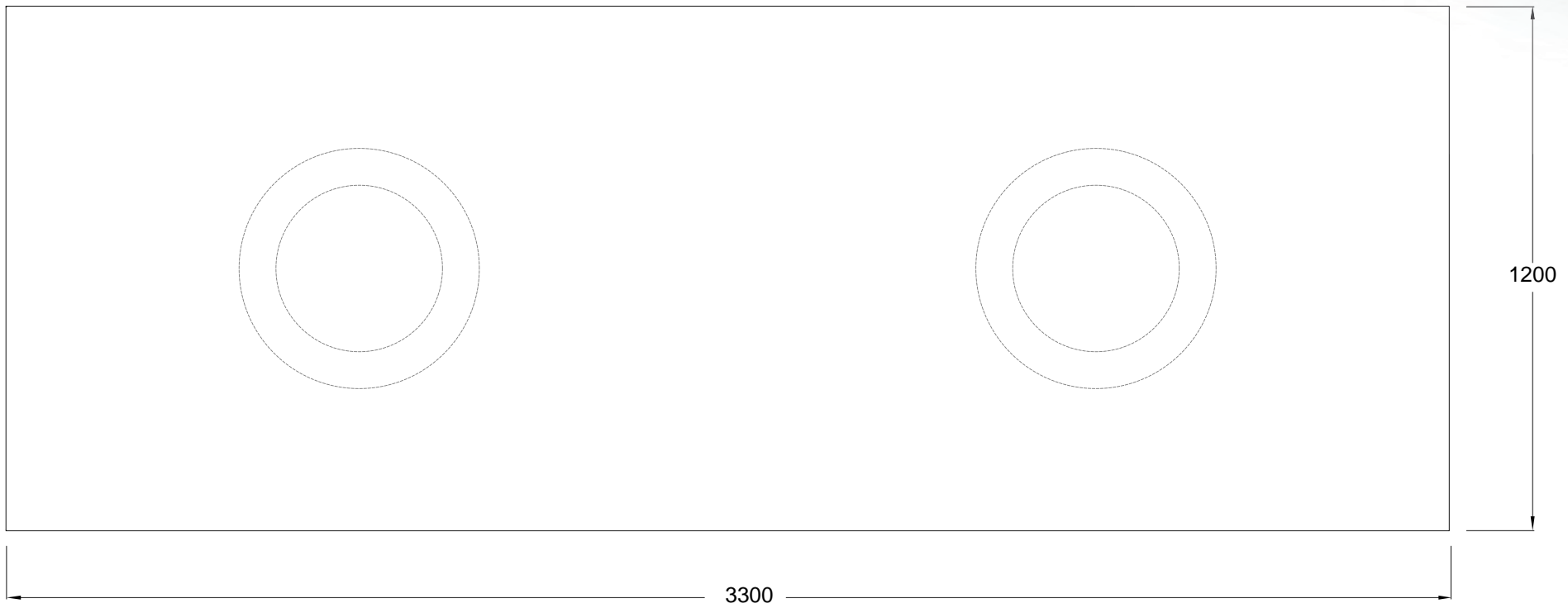

LIQUEUR TABLE [RECTANGLE]

LQ_TB.360x120[RECTANGLE]

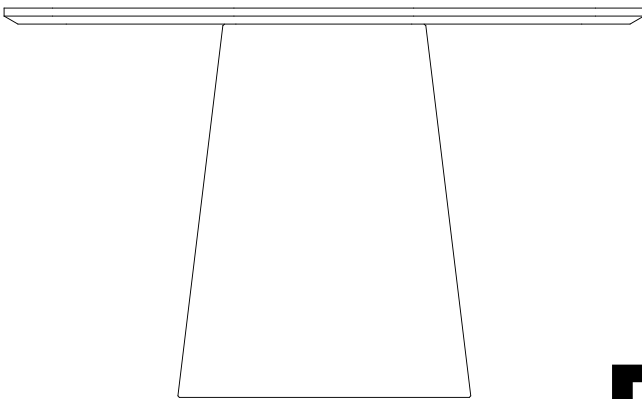
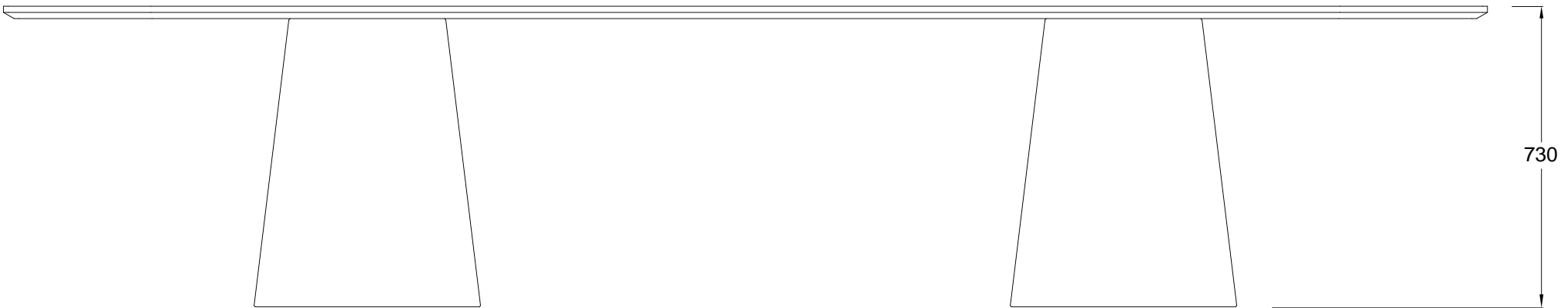
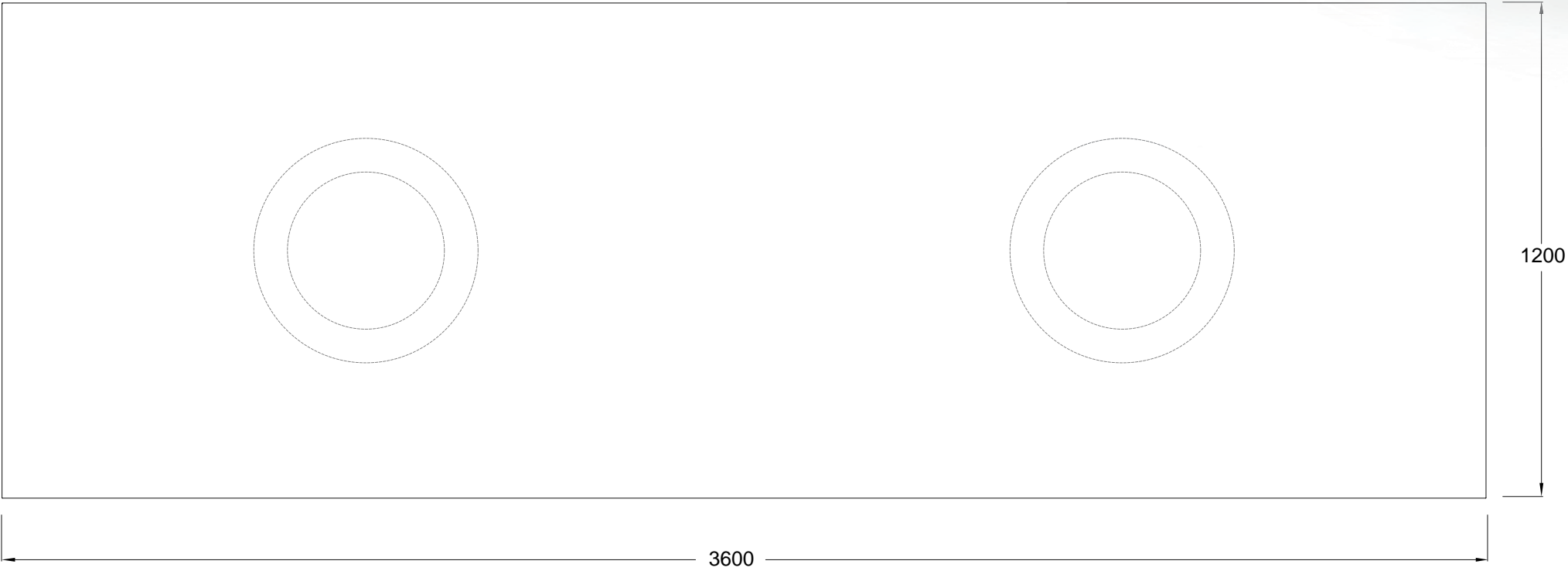

LIQUEUR TABLE [RECTANGLE]

LQ_TB.270x135[RECTANGLE]

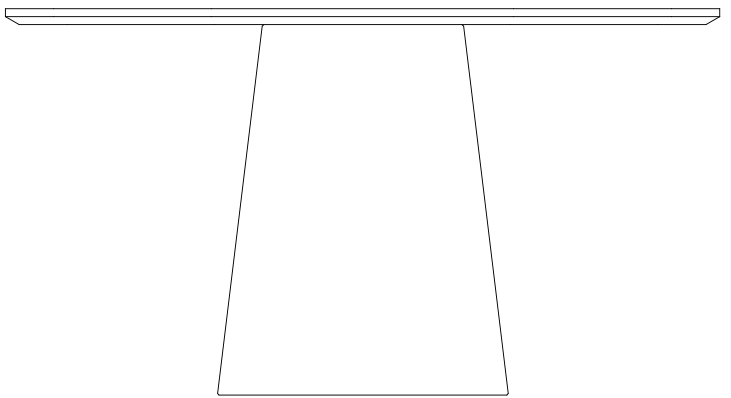
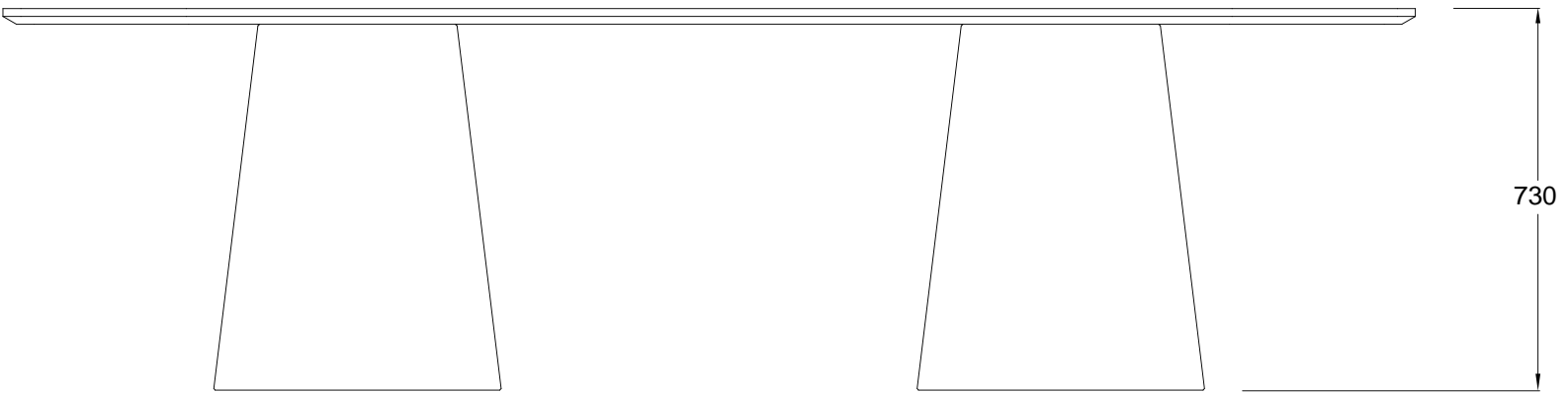
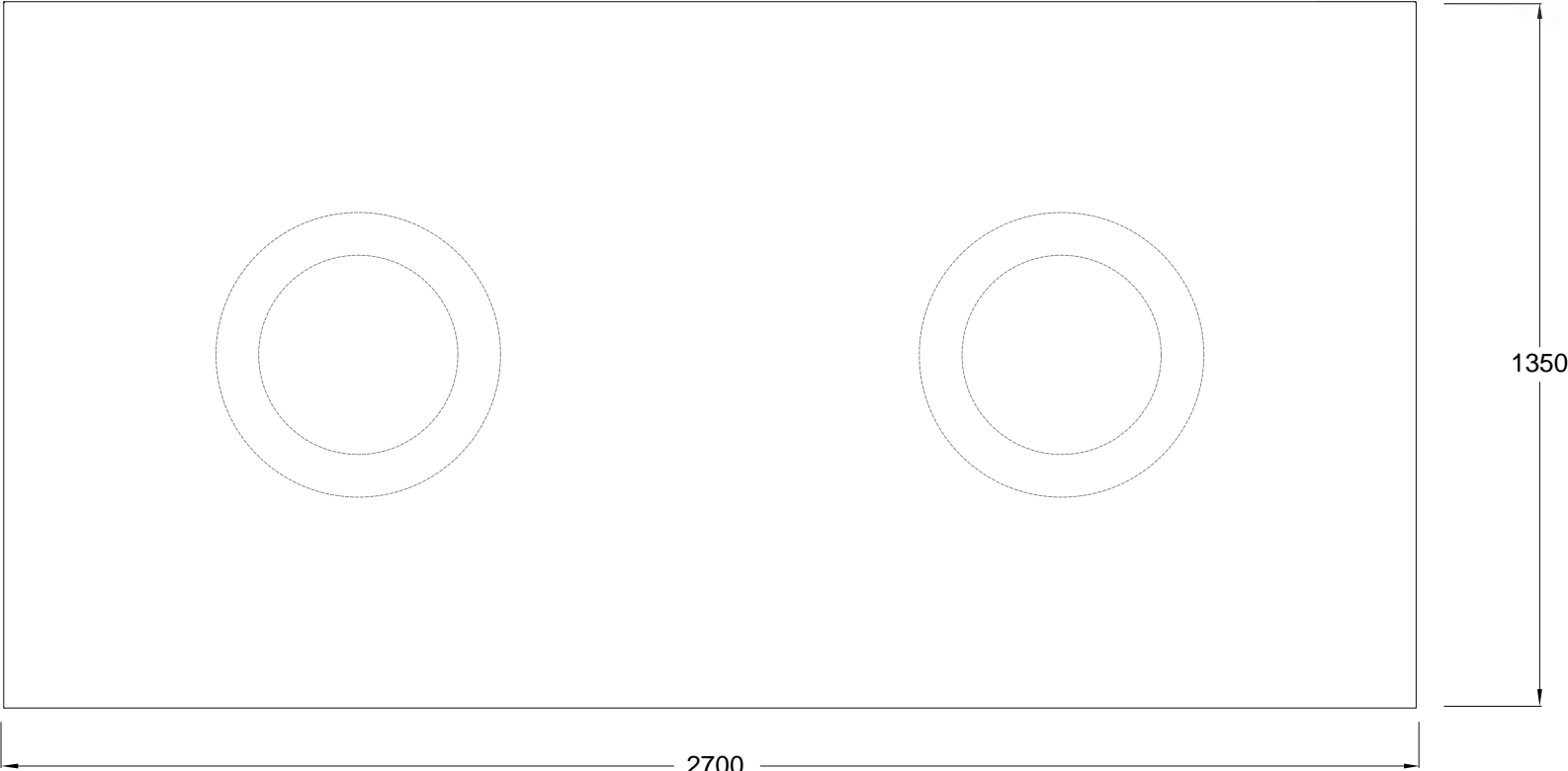

LIQUEUR TABLE [RECTANGLE]

LQ_TB.300x135[RECTANGLE]

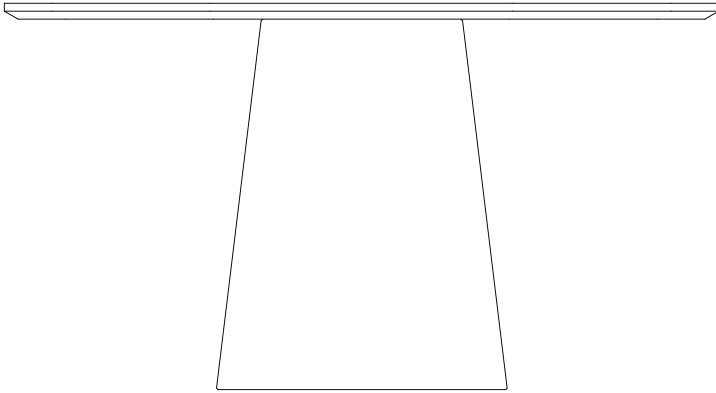
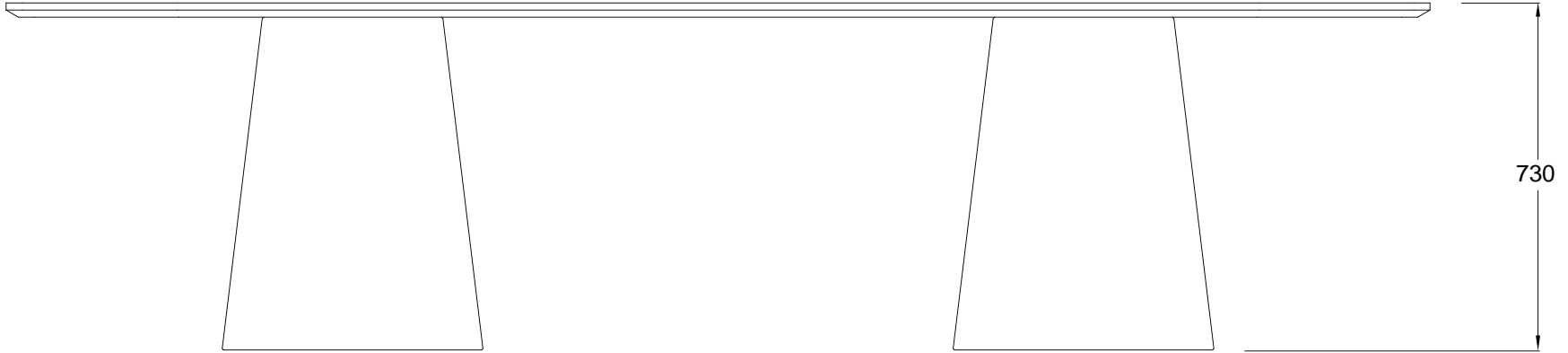
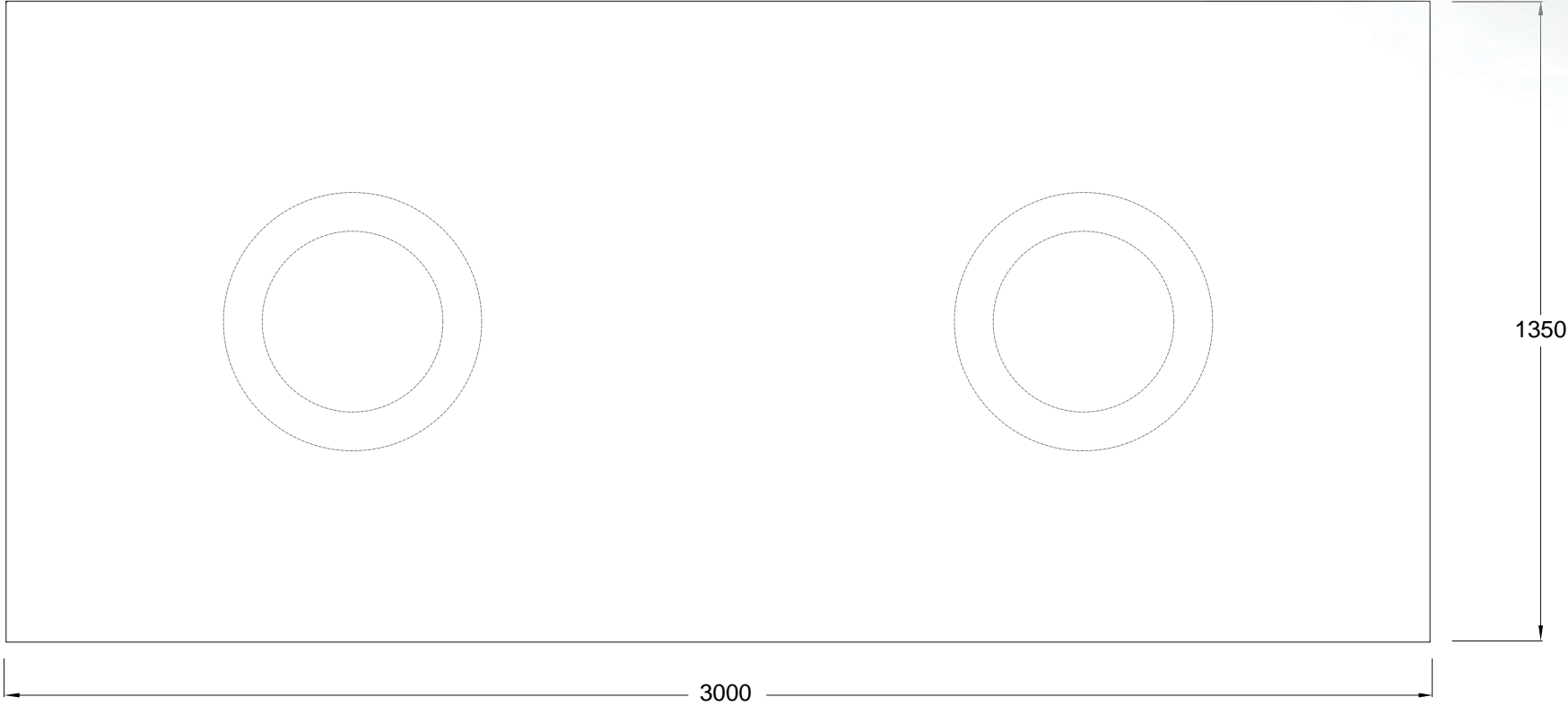

LIQUEUR TABLE [RECTANGLE]

LQ_TB.330x135[RECTANGLE]

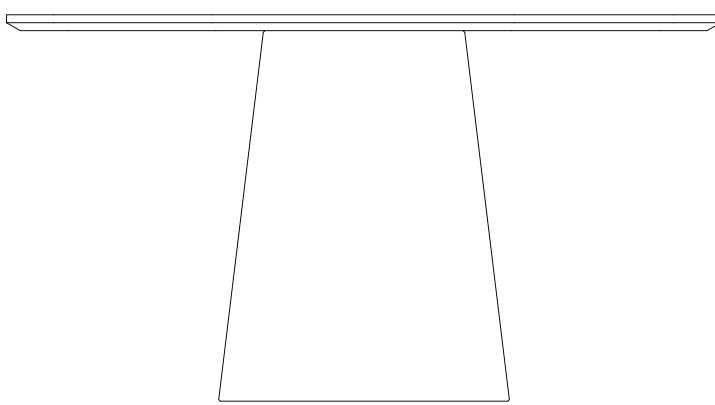

LIQUEUR TABLE [RECTANGLE]

LQ_TB.360x135[RECTANGLE]

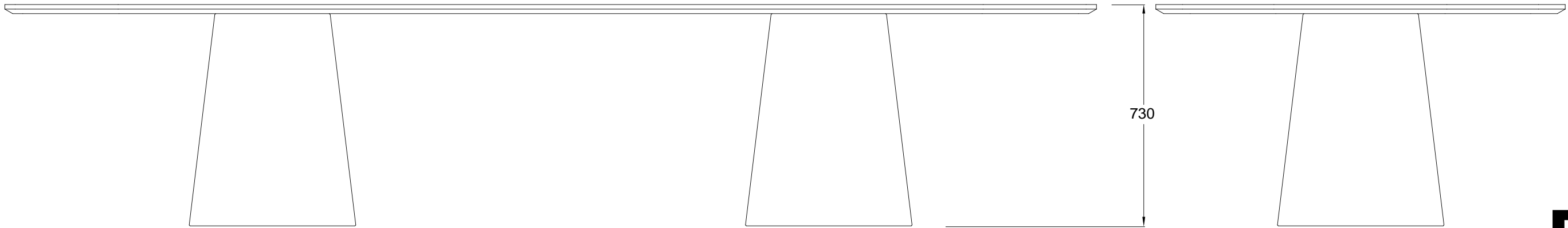
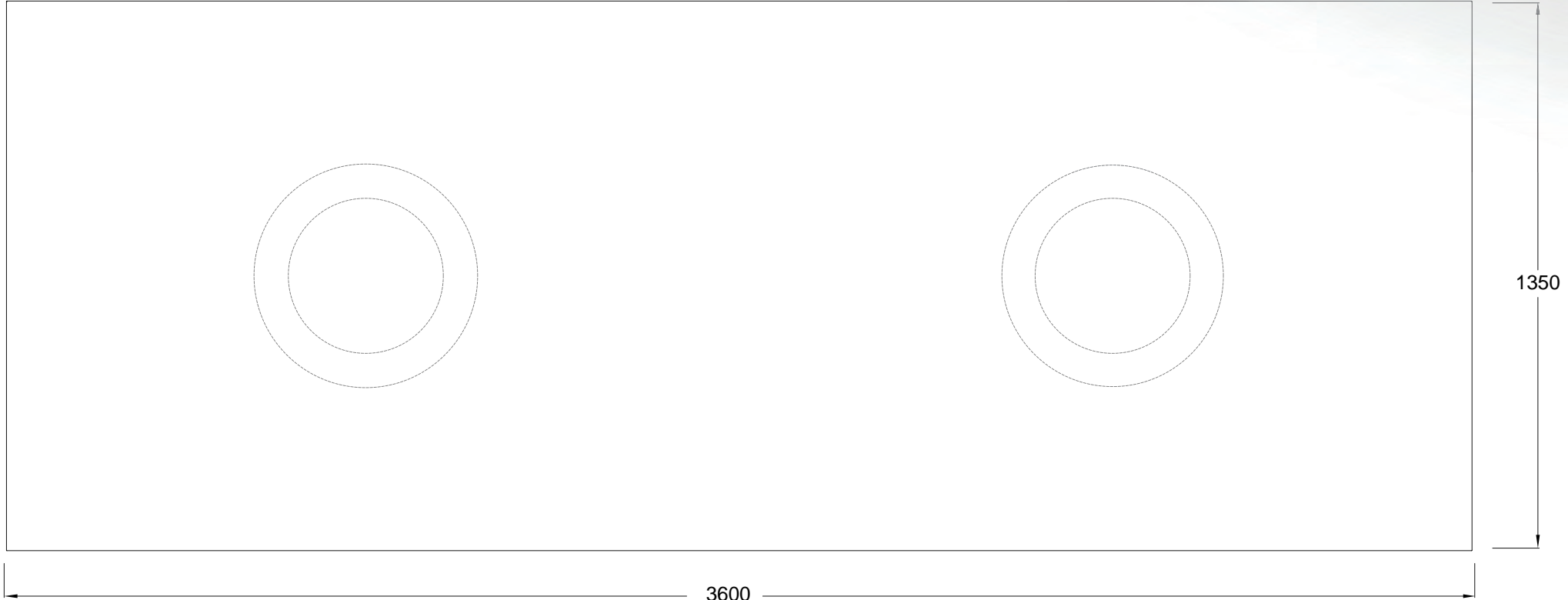

LIQUEUR TABLE

LQ_TB.90-DIA

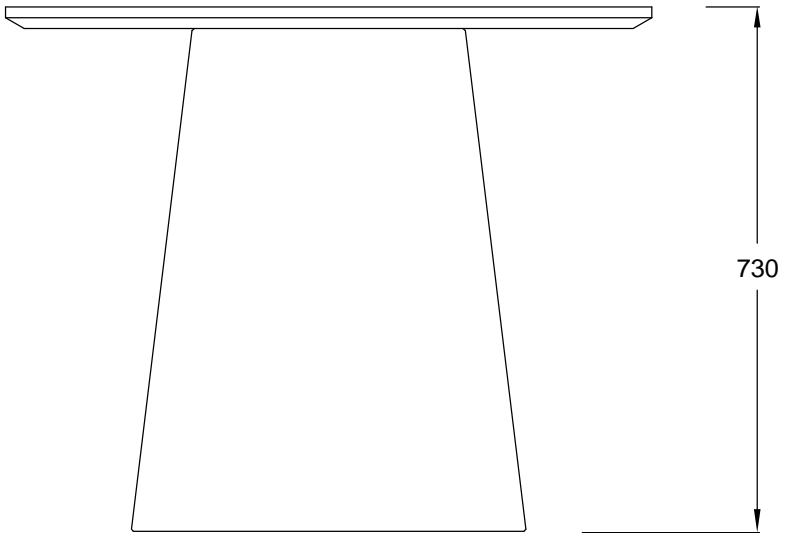
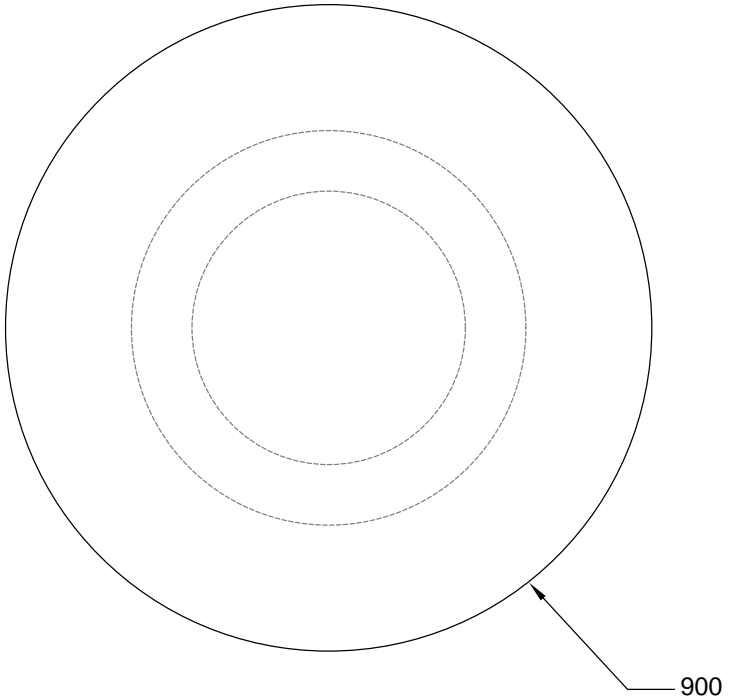

LIQUEUR TABLE

LQ_TB.105-DIA

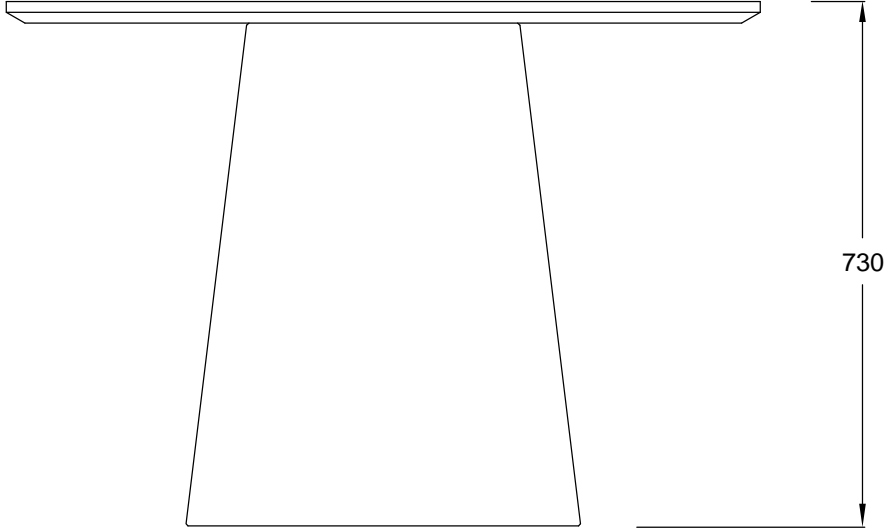
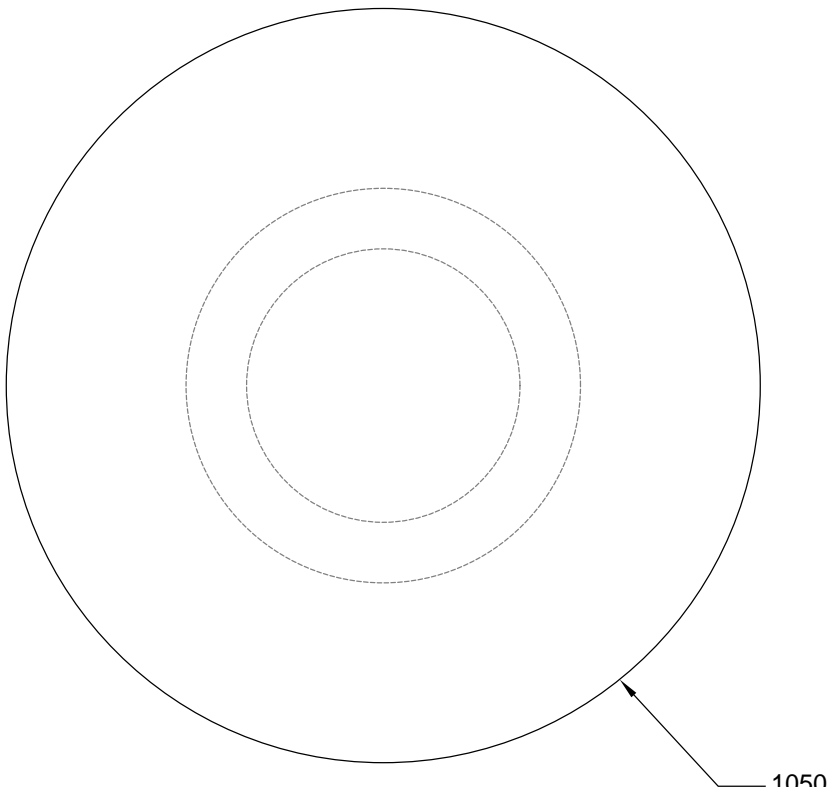

LIQUEUR TABLE

LQ_TB.120-DIA

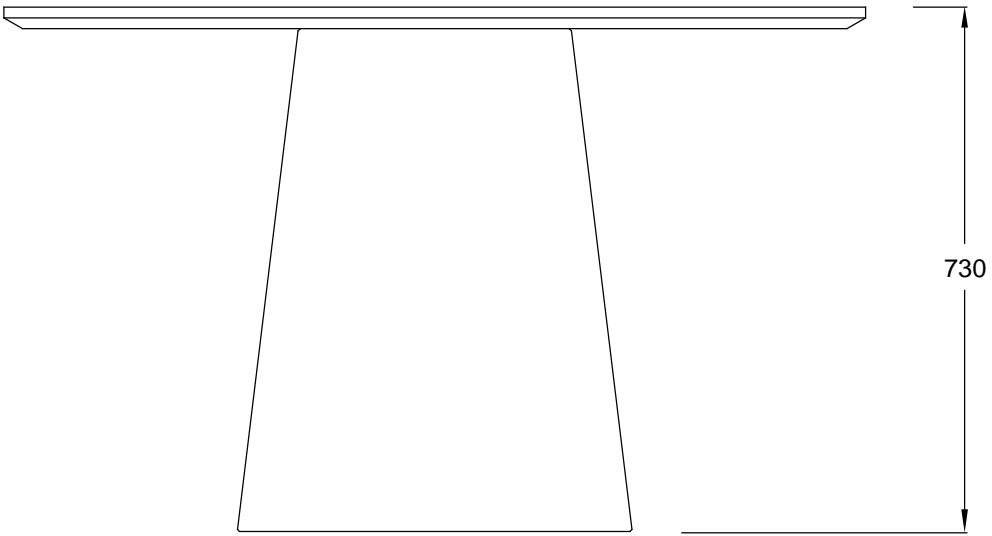
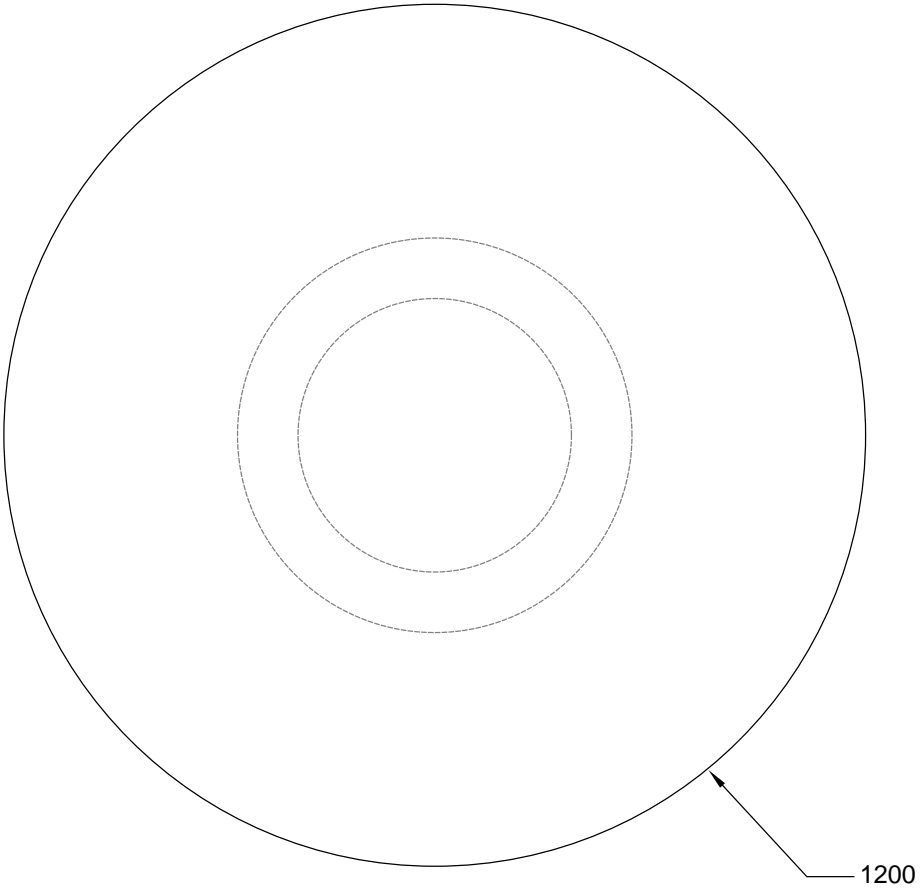

LIQUEUR TABLE

LQ_TB.135-DIA

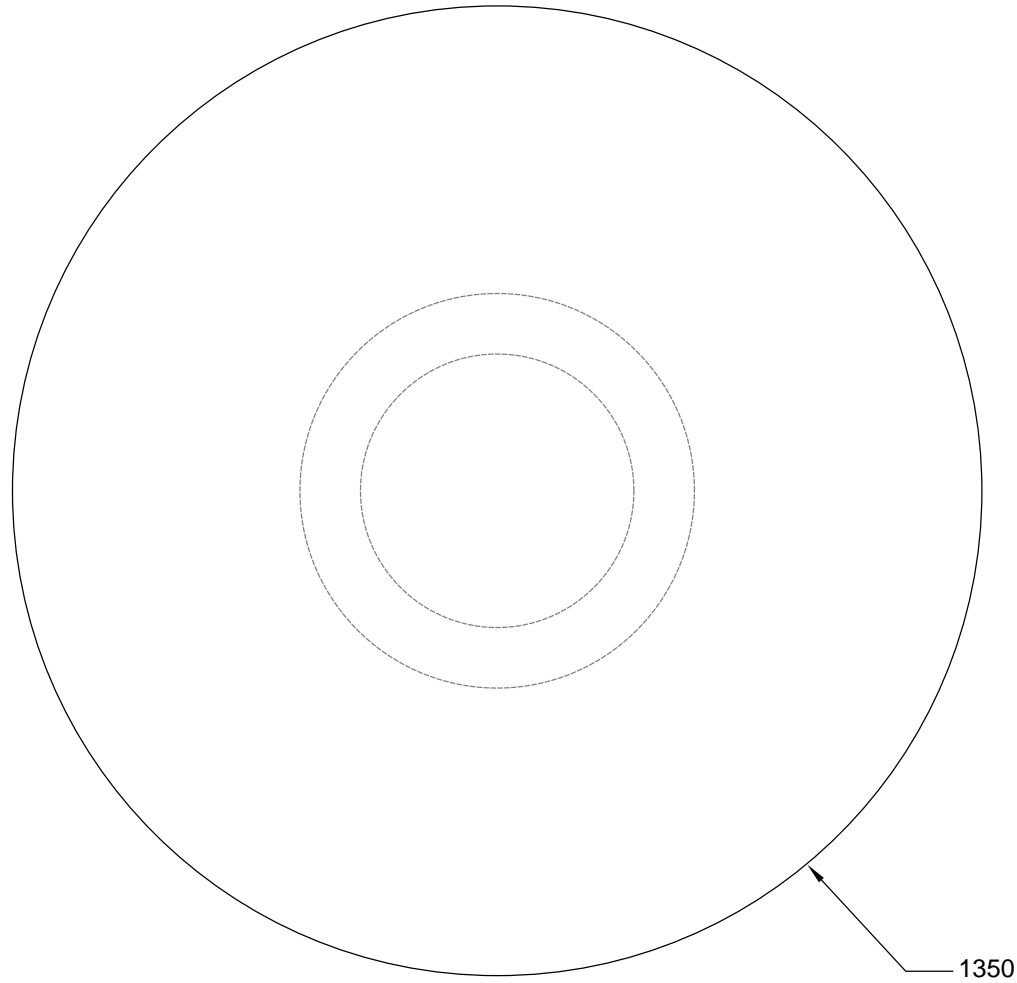

1350

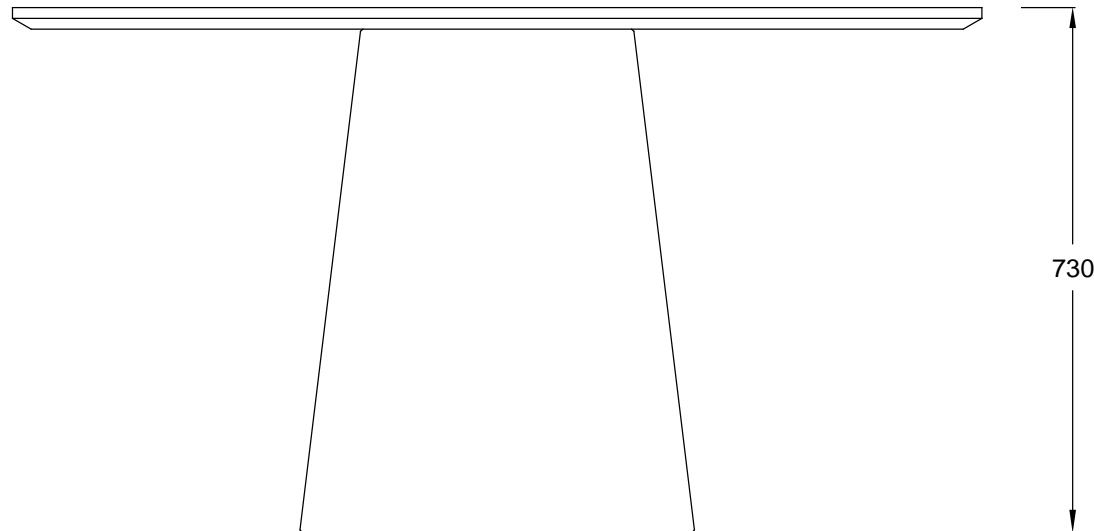

730



LIQUEUR TABLE

LQ_TB.150-DIA

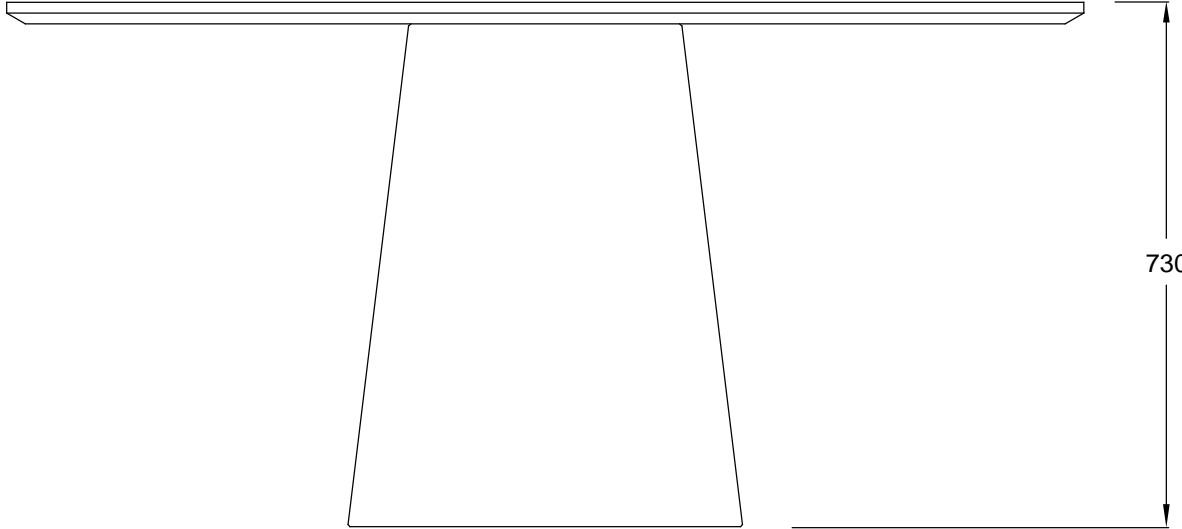
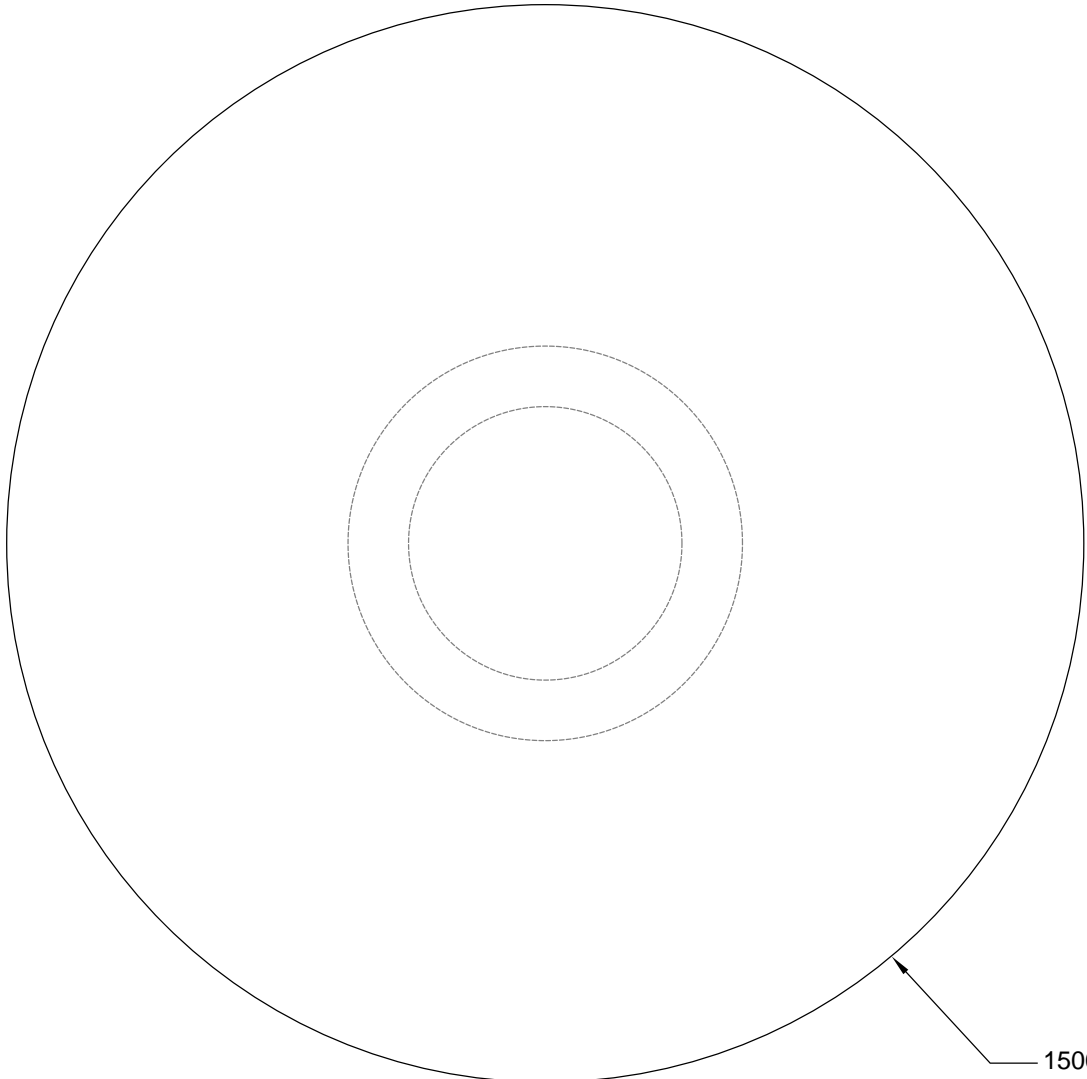

LIQUEUR TABLE

LQ_TB.180-DIA

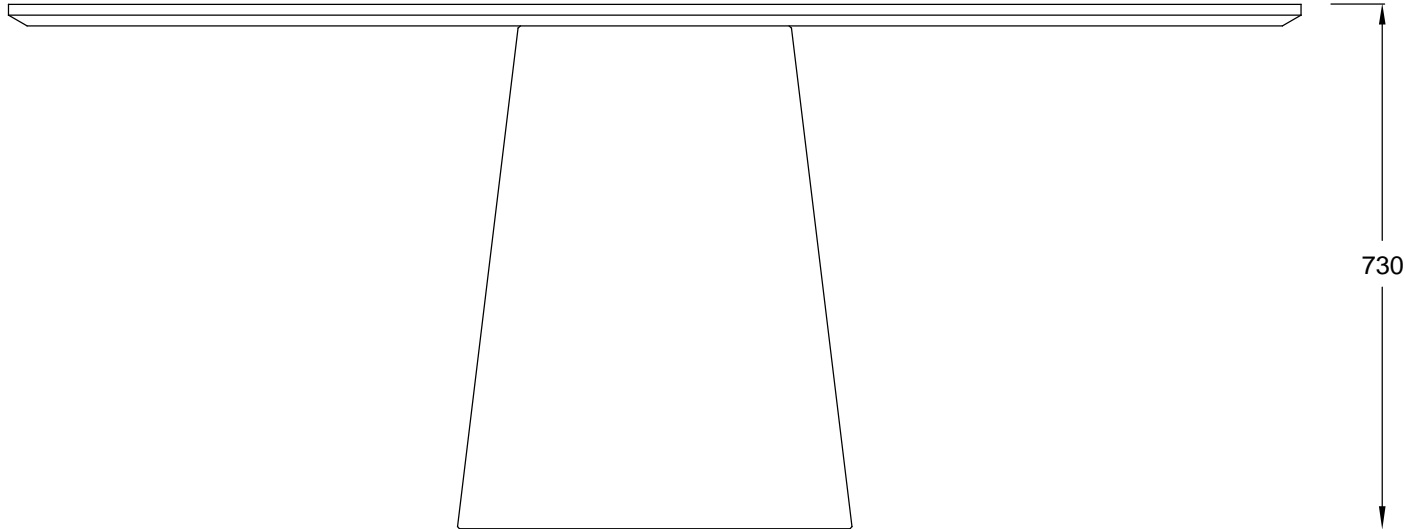
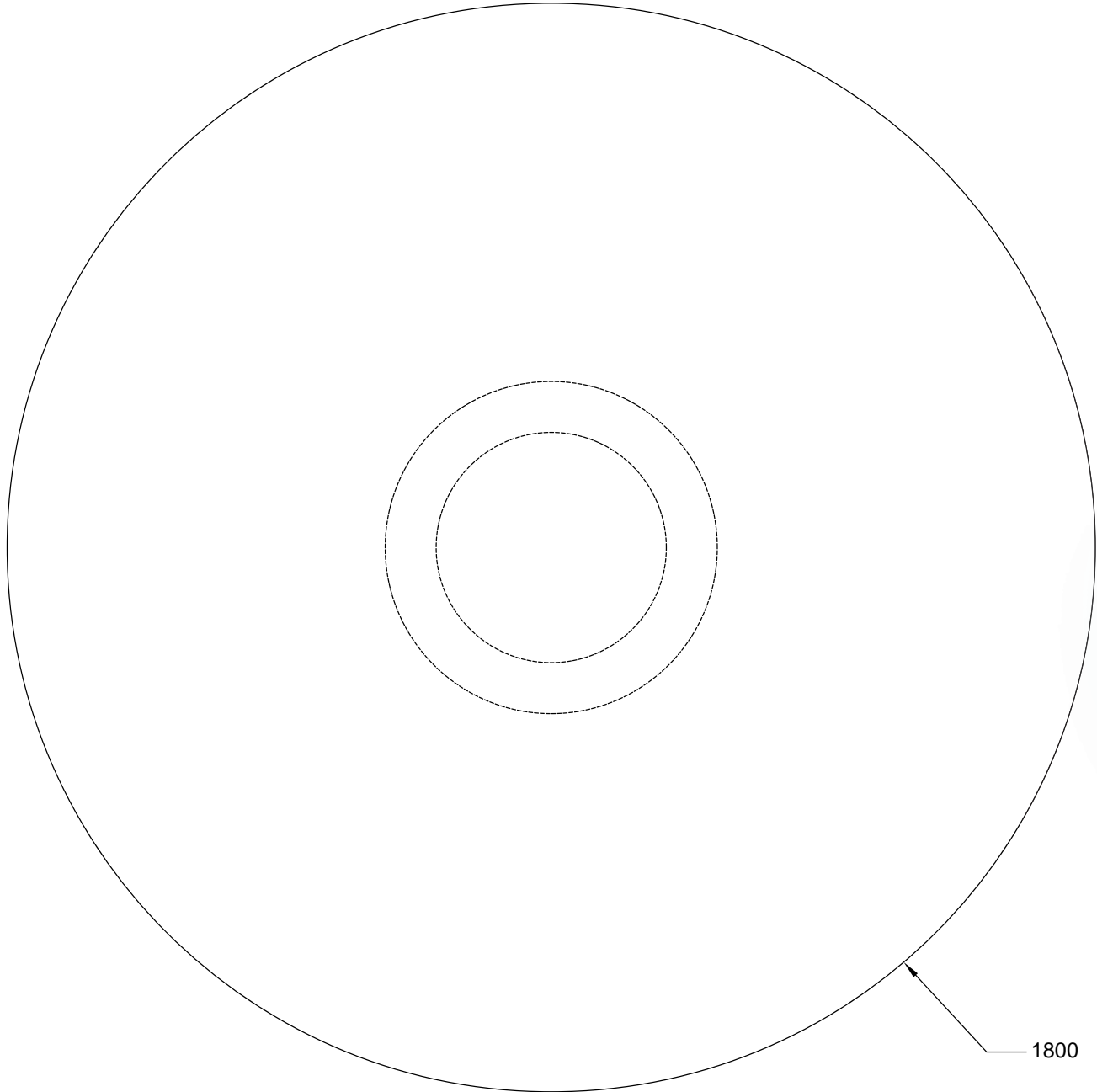

LIQUEUR TABLE

LQ_TB.80X80

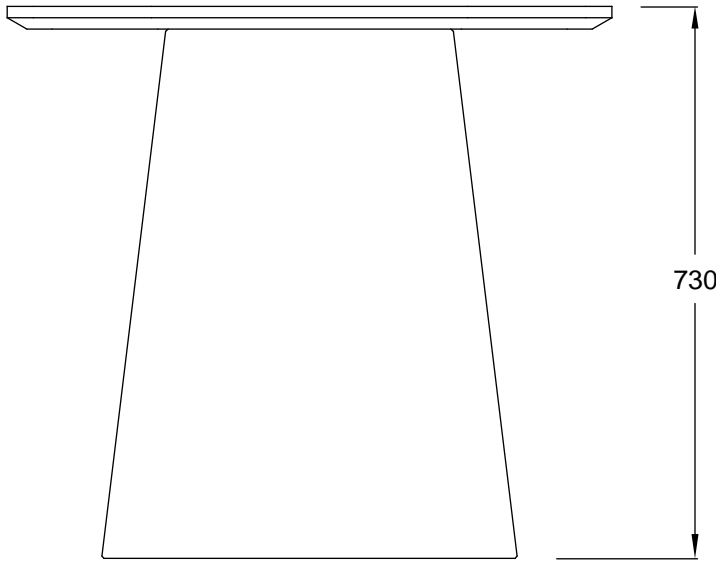
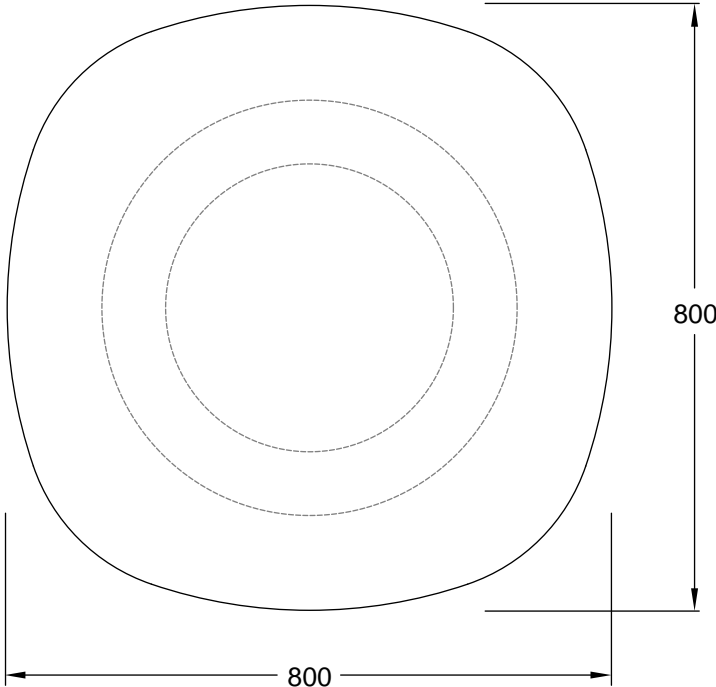

LIQUEUR TABLE

LQ_TB.115X115

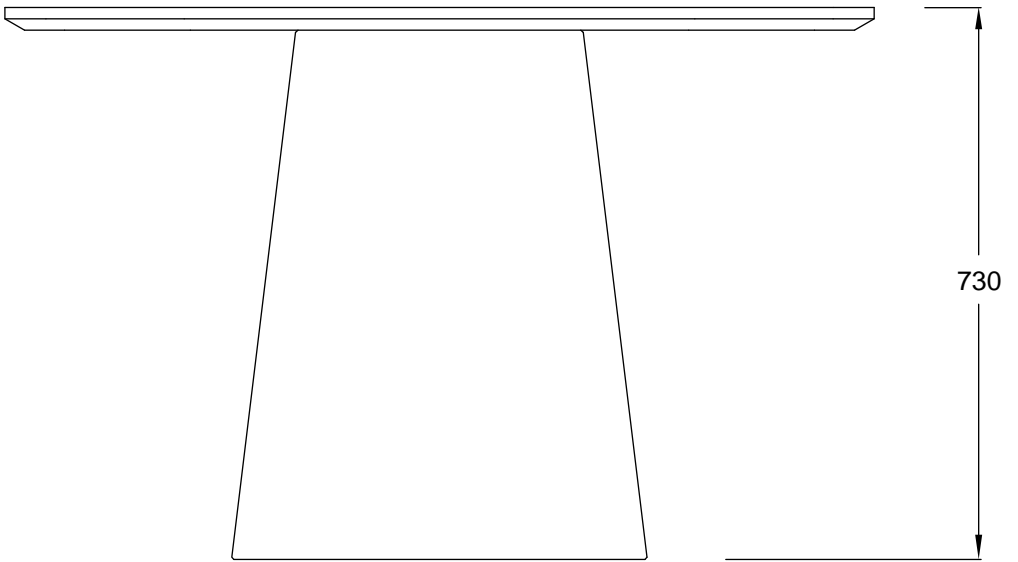
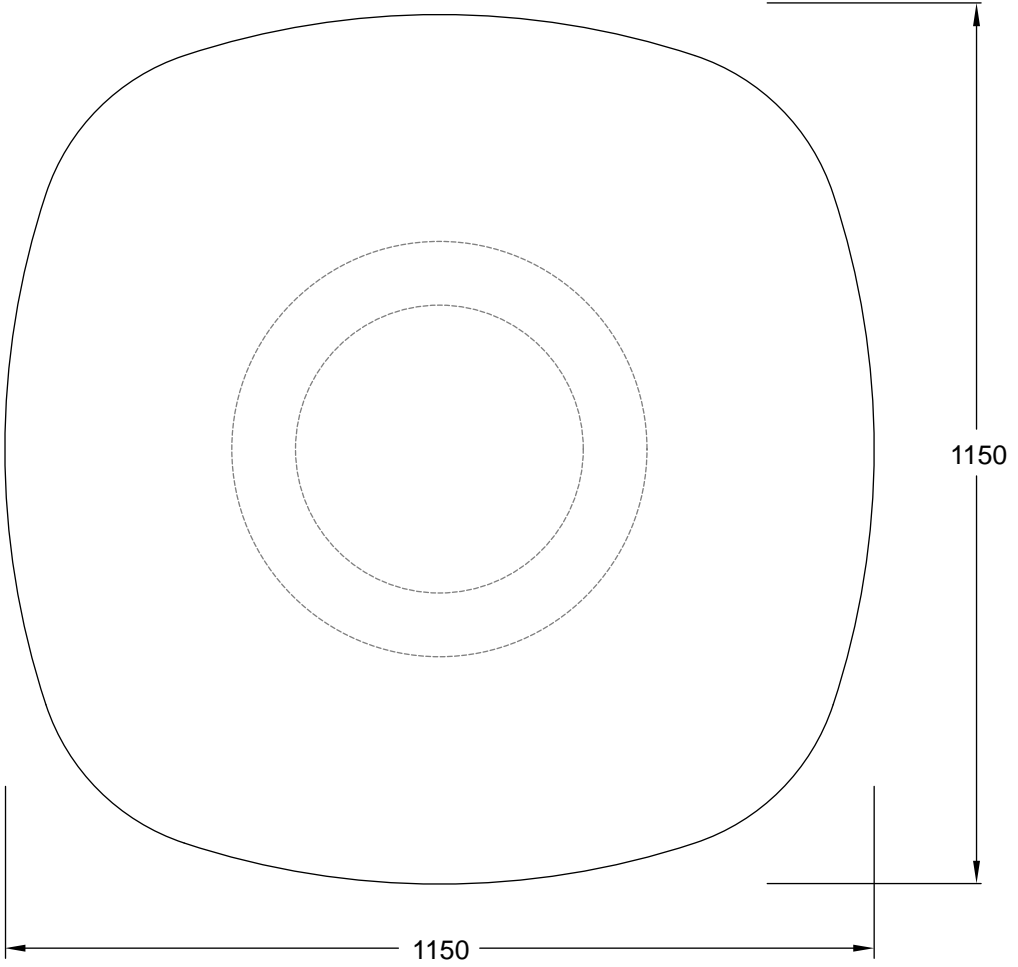

LIQUEUR TABLE

LQ_TB.150X150

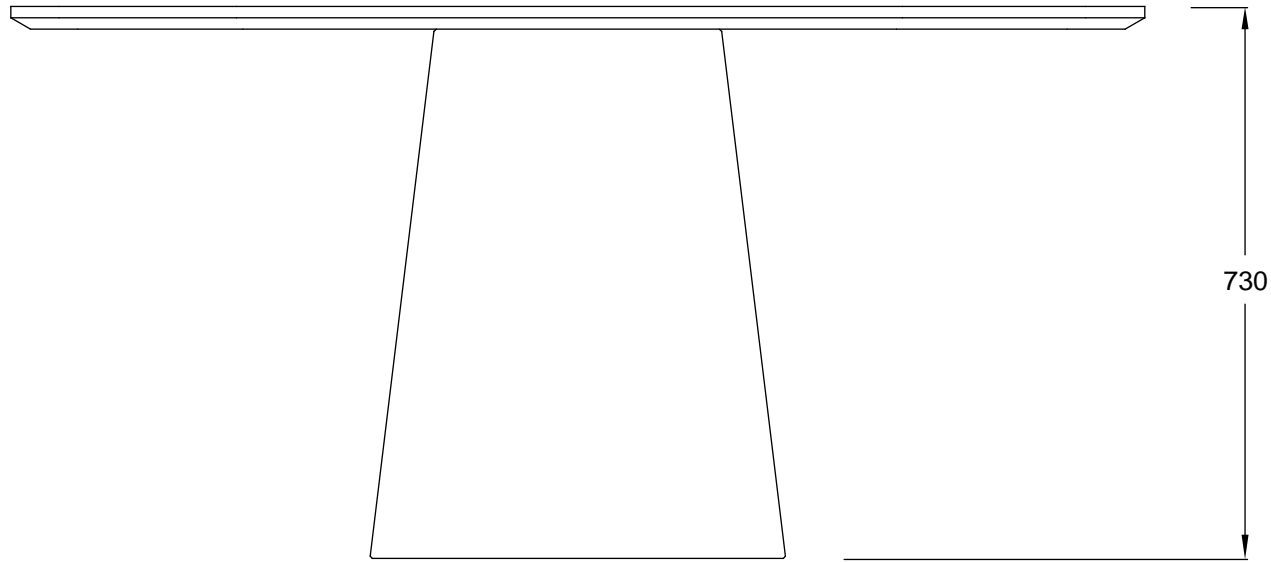
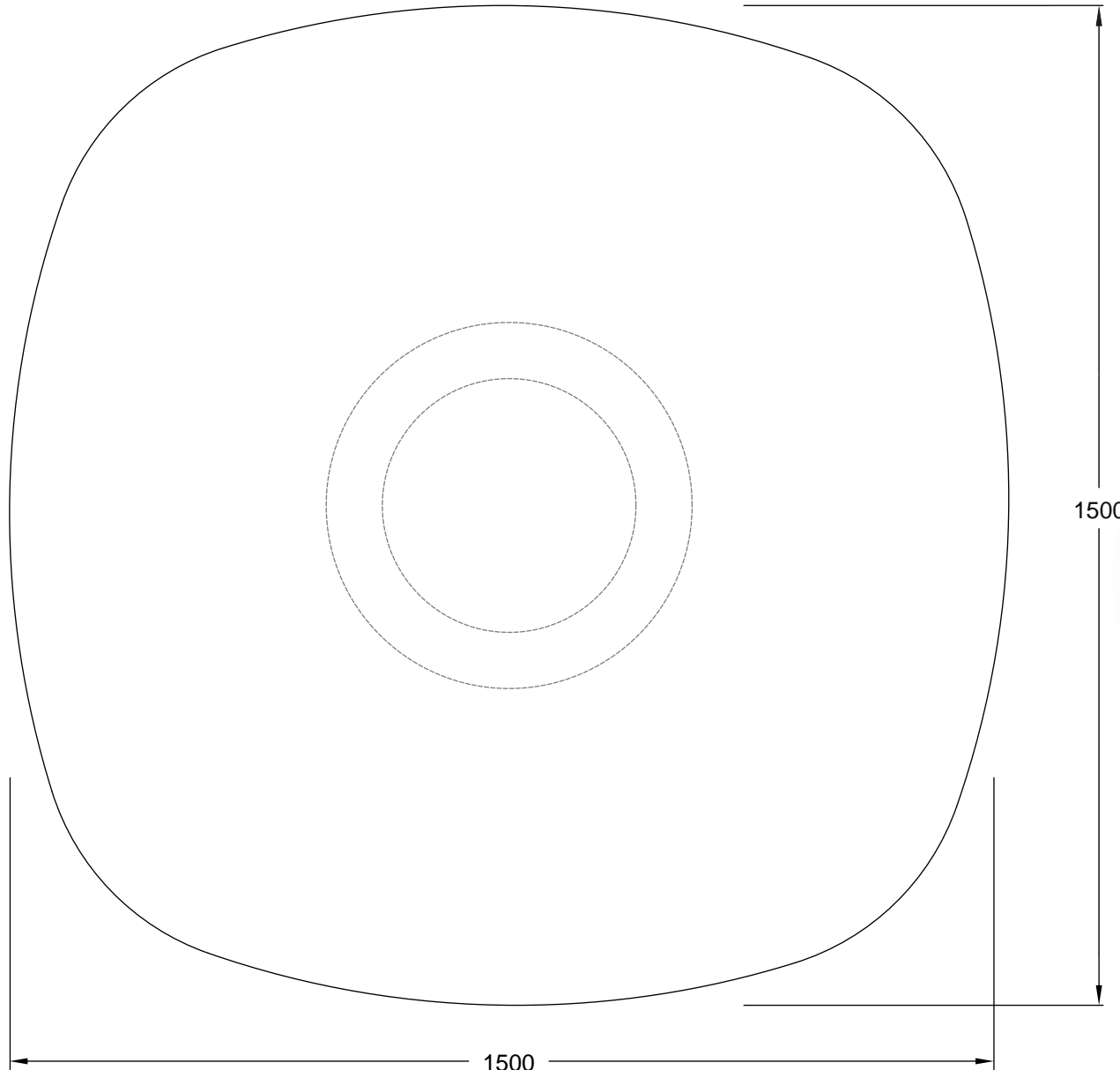

LIQUEUR TABLE

LQ_TB.80x80[SML]

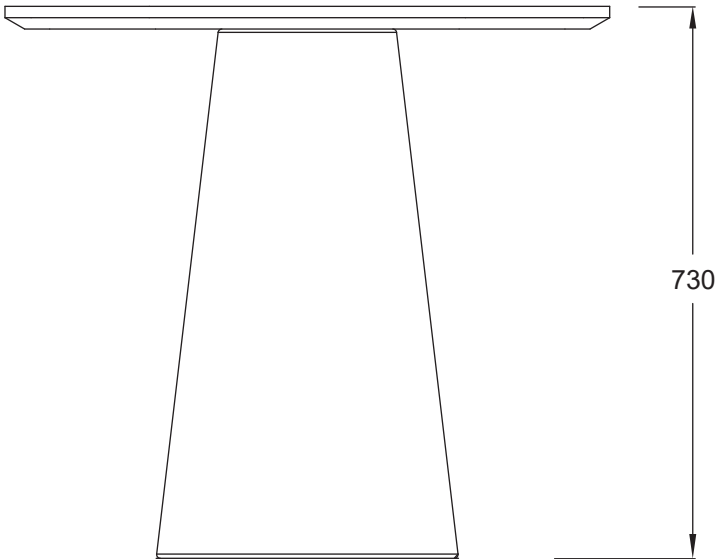
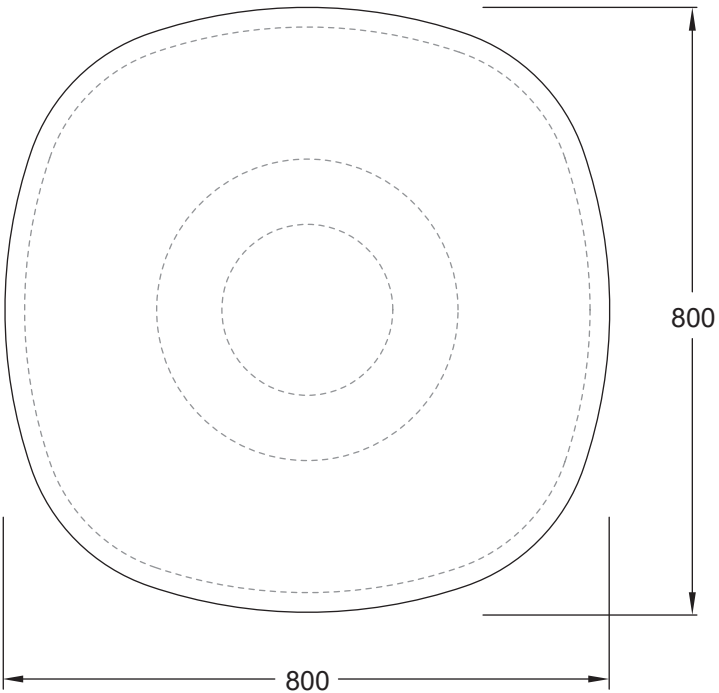

LIQUEUR TABLE

LQ_TB.105x105[SML]

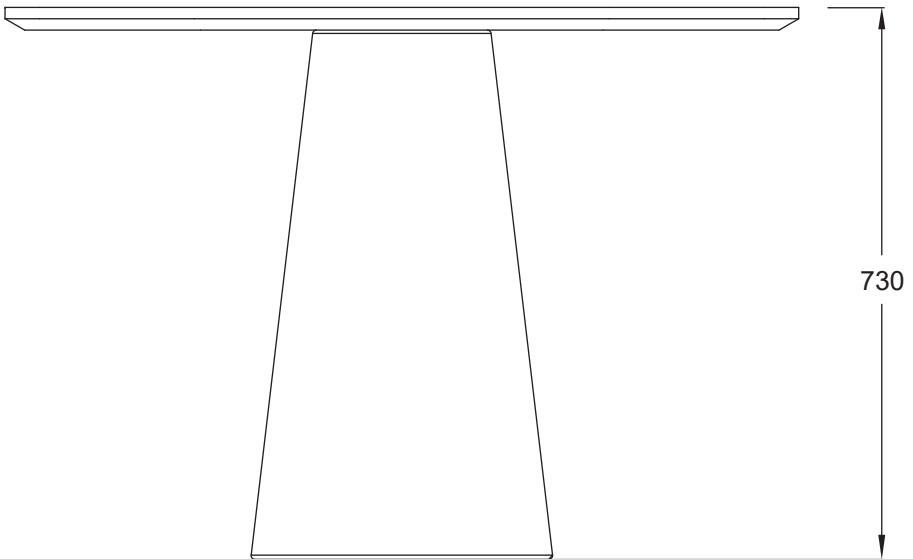
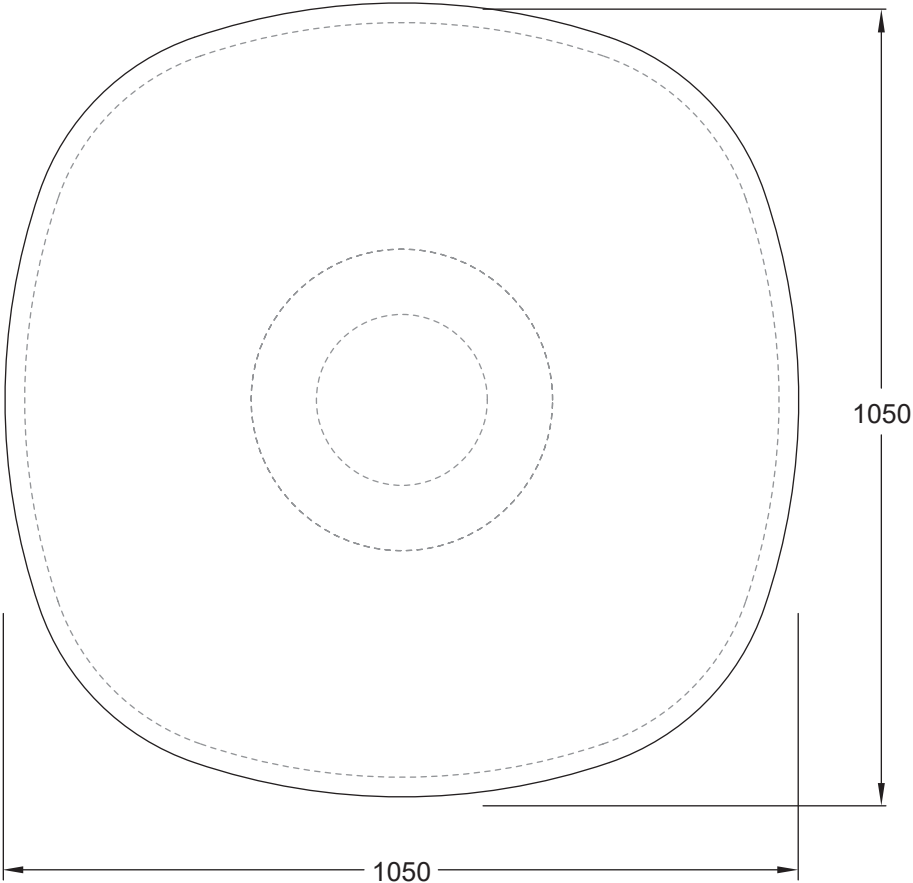

LIQUEUR TABLE

LQ_TB.90-DIA[SML]

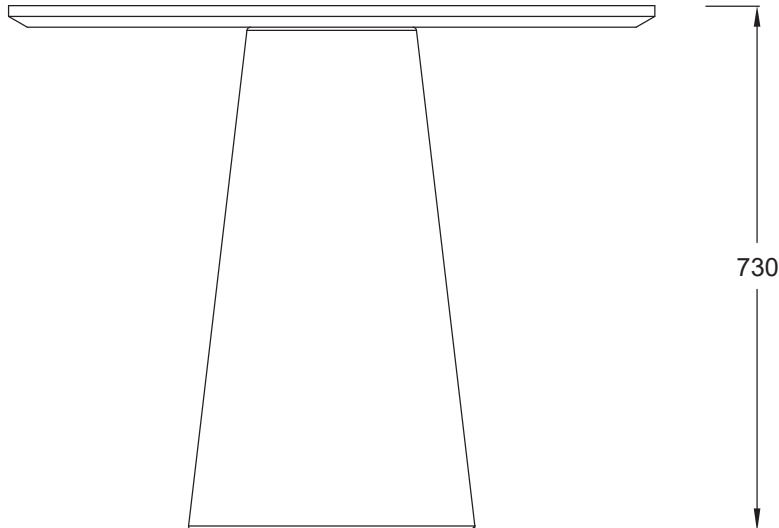
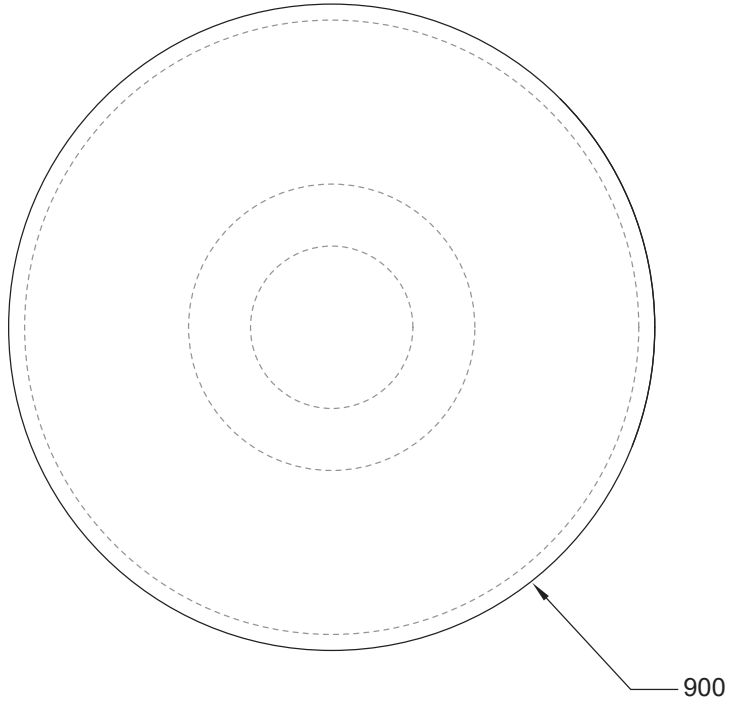

LIQUEUR TABLE

LQ_TB.105-DIA[SML]

